

FINAL REPORT

The Next Steps

In Exploring Deep Space

*A Cosmic Study
by the
International Academy of
Astronautics*

9 July 2004

Executive Summary

The purpose of this report is to articulate a *vision for the scientific exploration of space* in the first half of the 21st Century. The compelling scientific and cultural imperatives that guide this vision provide the context for a *logical, systematic, and evolutionary architecture for human expansion* into the solar system. This architecture represents a new approach leading ultimately to human exploration of Mars and a permanent human presence in the solar system.

Within this framework, *scientific objectives are used to determine the destinations* for human explorers, and each successive destination and new set of capabilities is established as a stepping-stone to further exploration. *Robotic missions continue to play a key role* in achieving the science objectives and preparing for human exploration. Such an integrated robotic-human exploration program can be *safe, cost-effective, exciting, and scientifically rewarding*, and thus can have the public appeal and political support that are prerequisites for *sustainable* long-term human exploration beyond low Earth orbit.

This report was developed on a volunteer basis under the auspices of the International Academy of Astronautics. It is not a strategic implementation plan for any national space program; rather, it represents a vision for the future that can be considered by interested space agencies, hopefully in the context of an international cooperative endeavor. This report provides a sampling of scientific opportunities and exploration options, not a comprehensive plan or a detailed technical blueprint. It is an example of what could be done, not a prescription of what will be done.

Imperatives and Science Goals

There are several imperatives that have drawn humankind into space and that now provide the impetus for human exploration of the solar system. In contrast to the era of the Space Race and the Cold War, today no single imperative is sufficient to motivate the investments and national willpower required for human exploration beyond low Earth orbit. Rather, these factors must all be present in some combination in order for such a challenging endeavor to succeed.

The *cultural imperative* embodies the characteristic drive of humankind to expand beyond its boundaries and to explore the unknown.

The *political imperative* has previously been manifested in the desire of nations to compete for technological superiority; now, hopefully, it can represent a unifying context within which interested nations can work together toward achievement of a common long-term goal.

Finally, the *scientific imperative* drives the desire to understand our natural world and the universe around us. The public continues to view space as an exciting new frontier for exploration, and has shown that it will support space exploration in pursuit of answers to questions deeply rooted in the human consciousness:

Where do we come from?

What will happen to us in the future?

Are we alone in the Universe?

Today we are able to begin to answer these questions. They form the basis for definition of compelling scientific goals, from which we derive exploration objectives and specific destinations in space.

Scientific Framework for the Exploration Architecture

<i>Translate compelling questions...</i>	<i>to science goals...</i>	<i>to exploration objectives...</i>	<i>at specific destinations.</i>
Where did we come from?	Determine how the universe of galaxies, stars and planets began and evolved.	Survey matter in the universe across the spectrum and to the beginning of time.	with telescopes at Sun-Earth Libration Point L2
		Observe and understand the process of planetary system formation in the galaxy.	with telescopes at SEL2
		Survey the diversity and composition of small bodies in the solar system.	on Near-Earth Objects
	Determine the origin and evolution of our own Earth and its biosphere.	Search for evidence leading to understanding the origin of the Earth-Moon system.	in the regolith and rocks of the Moon
		Search for samples from the earliest episodes in the history of the Earth.	in Earth meteorites found on the Moon
		Obtain evidence on the Sun's history and its effect on Earth through time.	in the regolith and rocks of the Moon
What will happen to us in the future?	Determine the nature of the space environment and any cosmic hazards to Earth.	Determine the history of asteroid and comet impacts on Earth.	in the local cratering record on the Moon
		Determine the bulk properties and internal structures of NEOs.	at and on Near-Earth Objects
	Determine the potential for establishing permanent human presence in space.	Determine the utility of resource production on the Moon including lunar ice.	on the Moon
		Determine the utility of NEOs as potential resources for materials in space.	on Near-Earth Objects
Are we alone in the universe?	Determine if there is or ever has been extra-terrestrial life in the solar system.	Determine the geological and climatological histories of Mars.	on Mars
		Determine the history of water and its present distribution and form on Mars.	on Mars
		Search for past and current life.	on Mars and Europa
	Determine if there are Earth-like planets with evidence for life around other stars.	Search for terrestrial-like planets around other stars.	with telescopes at SEL2
		Search for evidence of life in the observational properties of extra-solar planets.	with telescopes at SEL2

Destinations and Architecture

Four key destinations emerge as the most important targets for human explorers: the **Sun-Earth Libration Point L2 (SEL2)**, **the Moon**, **Near-Earth Objects (NEO's)**, and **the planet Mars**. Robotic missions to each of these destinations will enable human exploration to follow in a logical and evolutionary manner, the ultimate goal being establishment of a human presence on

Mars for science and exploration. All intermediate activities are designed to make progress toward that goal; in the process, they provide important opportunities for scientific discovery and they stimulate the development and validation of the infrastructure to support permanent human presence throughout the solar system. The program is made sustainable through establishment of a progressive set of goals, with relatively short time scales and regular discoveries that will maintain public interest.

The first destinations, SEL2 and the Moon, will finally take humankind beyond low-Earth orbit once again. The experience and spaceflight capabilities developed for those missions will be evolved to enable the next step: a journey to a Near-Earth Object, which will be humanity's first voyage beyond the gravitational influence of Earth. Building on that will come the first trips to another planet; the first may be targeted to one of Mars' moons to establish a foothold in the Martian system, to be followed by human missions to the surface of the Red Planet.

This *stepping-stone approach* will gradually build the required capabilities and will maintain interest and support by achieving important scientific discoveries at every step. Rigid schedules will not drive development decisions. Instead, the hallmarks of this architecture are its *flexibility* and *affordability*: Destinations and missions can be inserted, removed, or modified as needed to adjust annual investments, manage mission risk, and respond to discoveries and technological progress. The guiding principles of this architecture are:

- **Goal-driven:** Include only those destinations that are scientifically and culturally compelling and for which human capabilities are both suitable and beneficial.
- **Separate cargo and crew:** Maximize efficiency and crew safety by focusing transportation tasks. Minimize crew flight time by off-loading heavy cargo and scientific equipment onto dedicated cargo vehicles sent in advance of the crew for rendezvous at the destination.
- **One major new development per destination:** Establish a flexible sequence of destinations and missions such that only one major new capability is required for each step, coupled with evolutionary progress in existing capabilities.
- **Emphasize use of existing transportation tools:** Require no fundamentally new and expensive propulsion systems or launch vehicles, but rely instead on proven technologies and on astronaut capabilities for in-space assembly and fueling of reusable systems.

By spreading the major new developments among the four major architectural steps we can establish a set of logical, affordable steps into the solar system.

Exploration Steps and New Capabilities

Step	Destination	Major New Capability	Alternative Destinations
1: Beyond LEO	Moon, Sun-Earth L2	Geospace Exploration Vehicle	High Earth Orbit Earth-Moon L1 or L2
2: Deep Space	Near-Earth Objects	Interplanetary Transfer Vehicle	Deep space test flight
3: On to Mars	Phobos/Deimos	Cargo Transport Vehicle	Mars orbit
4: Down to Mars	Mars surface	Mars descent/ascent system and surface habitat	None

A Gateway into the Solar System

Development of an affordable permanent human presence in space can be greatly enhanced by innovative use of the natural characteristics of the space environment. This architecture takes advantage of the gravitational characteristics of the Sun-Earth libration point known as L2 (SEL2) to reduce launch and in-space propulsion requirements. Balanced between the gravitational attractions of Earth and the Sun, spacecraft at SEL2 can be serviced, refueled, and efficiently transferred to any deep space destination, making use of novel trajectories and lunar and Earth gravity assists. Upon return from deep space, vehicles can be captured back into SEL2 for re-use, thus also allowing “re-use” of the launch energy that was originally invested to place the vehicle at SEL2. Supplies, fuel, and other cargo can be efficiently transferred to SEL2 using low-energy trajectories, and development of the required astronaut capabilities for in-space assembly and re-supply will pay vast dividends throughout the exploration architecture. Thus SEL2 can represent an early element of a truly permanent, reusable space exploration infrastructure, analogous to a mountain climber’s “base camp” at a convenient location below the high peaks. There are also important scientific reasons for astronauts to travel to SEL2, since it is the location of choice for the large, complex space telescopes that will study extra-solar planets and probe the deepest universe. Assembly and repair experience gained at SEL2, a relatively safe, benign destination in near-Earth space, will provide an important early validation of hardware and procedures prior to undertaking voyages to more challenging destinations. While additional trade studies are of course required, consideration should be given to SEL2 as a key early element of a robust exploration architecture that is evolvable, expandable, and that enables multiple missions to multiple destinations over a long period of time.

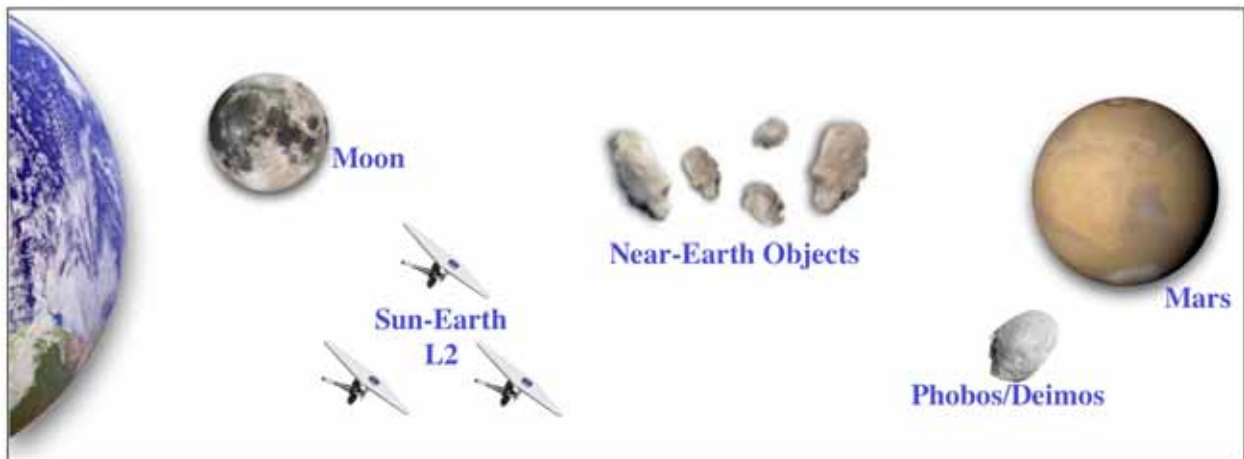

Stepping-stones into the solar system. An evolutionary architecture will enable logical, cost-effective, scientifically productive human expansion into the solar system. A series of intermediate destinations and a gradual development of new capabilities will lead to human exploration of Mars and a permanent human presence in the solar system

Engaging the Global Community

Human exploration of deep space is an ***intrinsically global*** enterprise. The report recognizes that several space-faring countries are developing their own space exploration “visions” as well

as “roadmaps” to achieve their goals. While the visions and roadmaps may differ, and while some countries may prefer not to depend on others for success, this report assumes that there will be numerous opportunities to coordinate activities and to cooperate in the achievement of long-term exploration goals.

Positive economic conditions and stable, mutually satisfactory political relationships are prerequisites for successful international collaboration. The challenges faced by countries interested in working together on space exploration projects will include cost, sustainability, acceptance of risk, and technology sharing. This study identifies Canada, China, Europe, India, Japan, Russia, and the United States as potential participants and discusses their exploration program interests and likely capabilities. The report notes that other countries – for example Australia, Brazil and South Korea – may have exploration interests and capabilities and that still other countries may eventually wish to participate. Though private sector organizations will develop, build, and operate many of the capabilities that are used in exploration programs, this study assumes that governments will provide most of the funding to initiate and conduct the early space robotic and human exploration missions.

This study considers the reasons countries have cooperated on prior space projects, identifies the coordination and cooperation approaches used over the past forty years and reviews some of the lessons learned from past international projects.

Countries pursuing space exploration may, as a first step, wish to establish a mechanism to exchange information on and coordinate program plans. Since national exploration visions are likely to differ, the steps each country pursues, the funding provided and the schedules followed will also differ. Accordingly, countries interested in cooperating on space exploration may prefer to do so in a step-by-step fashion instead of committing themselves to long term, multiple mission engagements. Ultimately, the approaches selected for collaboration on future robotic and human exploration missions will be determined by those countries seeking to participate, will probably be hybrid approaches drawing features from several earlier models, and will likely evolve as additional experience is gained.

Five initiatives that countries interested in space exploration could undertake to facilitate prospects for international coordination and cooperation are identified at the end of the report.

While collaboration with international partners can increase the complexity and the overall cost of national exploration activities, international coordination and cooperation – with the funding burden spread among several partners – can make space exploration activities *more* affordable, sustainable, and attractive to each of the participants. International collaboration on space exploration also provides opportunities for countries – some of which might otherwise be competitors – to work together on challenging enterprises that increase human knowledge and promote peaceful utilization of the solar system.

Study Principals

<i>Study Lead</i>	<i>Wesley T. Huntress, Jr.</i>	<i>Carnegie Institution of Washington</i>
<i>Study Executive Lead</i>	<i>Douglas Stetson</i>	<i>Jet Propulsion Laboratory</i>
<i>Science Lead</i>	<i>Wesley T. Huntress, Jr.</i>	<i>Carnegie Institution of Washington</i>
<i>Mission Design Lead</i>	<i>Robert Farquhar</i>	<i>Johns Hopkins/Applied Physics Lab</i>
<i>Architecture Lead</i>	<i>Douglas Stetson</i>	<i>Jet Propulsion Laboratory</i>
<i>International & Public Lead</i>	<i>James Zimmerman</i>	<i>International Space Services</i>
<i>Engineering Design Lead</i>	<i>Ben Clark</i>	<i>Lockheed Martin Corporation</i>
<i>History Lead</i>	<i>Roger Bourke</i>	<i>Jet Propulsion Laboratory (retired)</i>
<i>Program Synthesis Architect</i>	<i>William O'Neil</i>	<i>Jet Propulsion Laboratory (retired)</i>
<i>IAA/Workshop Lead</i>	<i>Bernard H. Foing</i>	<i>European Space Agency</i>

Contributions from Individuals

While affiliations are listed for the individuals contributing to this study, participation in this study was on an individual, volunteer basis.

Science

<i>Wes Huntress</i>	<i>(Lead)</i>	<i>Carnegie Institution of Washington</i>
<i>Bernard Foing</i>		<i>European Space Agency</i>
<i>Jim Head</i>		<i>Brown University</i>
<i>Harry Heisinger</i>		<i>Brown University</i>
<i>Joe Veverka</i>		<i>Cornell University</i>
<i>Steve Squyres</i>		<i>Cornell University</i>
<i>Jonathan Lunine</i>		<i>University of Arizona</i>
<i>John Mather</i>		<i>NASA/Goddard Space Flight Center</i>
<i>Richard Vondrak</i>		<i>NASA/Goddard Space Flight Center</i>

Mission Design

<i>Robert Farquhar</i>	<i>(Lead)</i>	<i>Applied Physics Laboratory</i>
<i>Yangping Guo</i>		<i>Applied Physics Laboratory</i>
<i>David Dunham</i>		<i>Applied Physics Laboratory</i>
<i>Bill O'Neil</i>		<i>Jet Propulsion Laboratory (retired)</i>
<i>Jozef van der Ha</i>		<i>European Space Agency (retired)</i>
<i>Jun' Kawaguchi</i>		<i>Japan Aerospace Exploration Agency</i>
<i>Tom Jones</i>		<i>NASA (retired)</i>

Program Architecture

<i>Doug Stetson</i>	<i>(Lead)</i>	<i>Jet Propulsion Laboratory</i>
<i>Ben Clark</i>		<i>Lockheed Martin Corporation</i>
<i>Robert Easter</i>		<i>Jet Propulsion Laboratory</i>

Policy and International

James Zimmerman (Lead)
Geraldine Naja
Risto Pellinen
Richard Obermann
Roger Bourke

International Space Services
European Space Agency
Finnish Meteorological Institute
Congressional Staff, U.S. House of Representatives
Jet Propulsion Laboratory (retired)

International (IAA/ESA) Workshop

Bernard H. Foing (Lead)
Anny-Chantal Levasseur Regourd
Jean Pierre Swings
Vincent Icxke
Oleg Korablev
Risto Pellinen

European Space Agency
Service d'aeronomie, France
University of Liege, Belgium
Leiden University, Netherlands
Space Research Institute, Russia
Finnish Meteorological Institute, Finland

And participants at the workshop

At <http://sci.esa.int/conferences/nexsteps2003/>

Contributions from Groups

Participants at the ESA/IAA Workshop on “The Next Steps in Exploring Deep Space” at ESTEC, Noordwijk, Netherlands, Sept 22-23, 2003.

Material provided by and meetings with the NASA Decadal Planning Team/NEXT study group, and especially contributions by Gary Martin and Harley Thronson of NASA.

Geology and planetary science students of Brown University (principally Patrick Russell, Wil Pomeranz and Wes Patterson), February 2001.

Planetary science postdocs and faculty at the University of Arizona, Spring 2001.

Acknowledgments

The Study Principals are grateful to their home institutions for support of their time and travel in conducting this all-volunteer study. The Study Lead conducted much of his work on this study as a Distinguished Visiting Scientist at the Jet Propulsion Laboratory, which also provided some support for managing and conducting this study. We are grateful to ESA and ESTEC for support of the ESA/IAA Workshop that contributed greatly to this study.

Table of Contents

<i>Executive Summary</i>	1
<i>Foreword</i>	9
<i>Introduction</i>	11
<i>Destinations</i>	11
<i>Architecture</i>	12
<i>Robotic and Human Scientific Exploration</i>	14
<i>The 21st Century Space Frontier</i>	16
<i>Historical Perspective</i>	16
<i>The Imperatives: Why We Explore Deep Space</i>	24
<i>Science</i>	29
<i>Where Did We Come From?</i>	29
<i>What Will Happen To Us in the Future?</i>	35
<i>Are We Alone in the Universe?</i>	39
<i>Destinations for Human Space Exploration</i>	45
<i>Architecture</i>	53
<i>Human Exploration: Imperatives and Requirements</i>	53
<i>Architectural Principles and Stepping-Stones</i>	53
<i>Step 1: Beyond Low-Earth Orbit</i>	55
<i>Step 2: Into the Solar System</i>	63
<i>Step 3: On to Mars</i>	71
<i>Step 4: Down to Mars</i>	77
<i>Integrated Technology Planning and Development</i>	85
<i>Trade Studies</i>	90
<i>Engaging the Global Community:</i>	
<i>Policy and International Cooperation Considerations</i>	93
<i>Prerequisites</i>	93
<i>Challenges</i>	94
<i>Potential Participants</i>	96
<i>Private Sector Participation</i>	104
<i>Cooperation Approaches</i>	105
<i>Lessons Learned</i>	109
<i>Next Steps</i>	110
<i>Resources</i>	112

Foreword

This is the final report of a study that was initiated by the principal authors through the International Academy of Astronautics (IAA). It originated with a speech given on the occasion of the lead author's induction as a member of the IAA in early 1999. The study was conducted on a volunteer basis by the authors, who developed their material through interaction with their colleagues throughout the governmental, industrial, and academic space exploration communities. We are grateful to all those who contributed their time and effort to advise and assist us in this work.

The authors worked primarily through telecons, email, and a small number of face-to-face meetings. Several gatherings were held with faculty and students at U.S. universities. A workshop on the scientific goals for future human space exploration was held in Europe, sponsored by the European Space Agency. The Jet Propulsion Laboratory graciously provided logistical support and supported the lead author to work on this project during visits to JPL.

The first interim report of this study was given at the IAA plenary at the World Space Congress in Houston, Texas, in October 2002. A second interim report was given during the IAA sessions at the International Astronautical Congress in Bremen, Germany, in October 2003. The final oral report is scheduled for a plenary session at the International Astronautical Congress in Vancouver, Canada, in October 2004. The study team has benefited from the many interactions that resulted from these open presentations.

As we complete this report for presentation to the IAA Commission I in March 2004, we are immensely gratified by the announcement of a new policy and direction for the U.S. space program and a new commitment to a vigorous program of human exploration of the solar system. We are particularly pleased that the overarching goals of this new space policy align very well with those that we have been advocating throughout this study. We are hopeful that establishment of this new exploration initiative truly represents the first step toward a productive, sustainable, and permanent international human presence in the solar system.

February 2004

Note added in July 2004: The authors wish to express their profound appreciation to their many international colleagues whose comments have been so valuable in preparation of this final report. Your diligent reviews of the earlier drafts have contributed greatly to what we hope is a useful and thought-provoking document. Thank you for so generously contributing your time and your expertise.

Preface

A hundred years ago, the Wright brothers changed the world with their daring and ingenuity. No one then could have predicted the explosive growth of aeronautics and how it would come to dominate global transportation. Fifty years ago, Collier's magazine published a series of articles that depicted a bold vision for space exploration. Some of the great engineering, scientific, and artistic minds of that generation, from both Europe and America, helped to craft that vision. Around the same time, Walt Disney popularized the unfamiliar concepts of spaceflight and captivated American public interest. With air travel commonplace, with technology progressing at stunning speed, and with an engaged and excited public, space travel seemed just around the corner—and indeed it was.

Worldwide interest in space was galvanized when the Soviet Union opened the Space Age with the 1957 launch of Sputnik. The U.S. responded to that political challenge, and the result, in addition to an incredible (and continuing) series of robotic missions throughout the solar system, was the Apollo program to the Moon—a logical sequence of missions focused on a clear destination, and carried out with a national willpower and political commitment not seen before or since. The Russian lunar program, although hidden behind a veil of secrecy, was no less ambitious. More than anything else, the race to the Moon was a demonstration to the world of the almost unlimited potential of scientists and engineers when given a challenge and supported by their country's leaders. And having at last set foot on another planetary body, a scant 66 years after the dawn of powered flight, humanity's potential for exploring, utilizing, and even colonizing the solar system seemed unlimited.

But the wave of progress broke after Apollo, and the world's human spaceflight programs have stayed frustratingly close to the shore. Little of the promise of those early decades has been realized. In the view of many, human space flight has been mired in Earth orbit and the public has grown apathetic. Strong sentiments have recently emerged that there must be clear destination and purpose for human spaceflight, and that humankind needs, in a very fundamental way, the scientific knowledge, the technological challenge, and the sense of discovery and progress that only space exploration can provide. The people of many nations long to explore the frontier and to share in its promise—the growing space programs of Europe, Japan, India, and China are testament to that. A well-conceived international program of human space exploration can advance discovery, understanding, and cooperation—it can lift our sights and fuel our dreams. But such a program must do much more than just endlessly circle the globe—*it needs to go somewhere!*

Introduction

The purpose of this report is to provide one possible vision for the scientific exploration of space in the first half of the 21st Century. We focus on human exploration in the context of a complementary and supportive robotic exploration program, and seek to define a logical, systematic, and evolutionary roadmap for human exploration of the solar system. Scientific goals and objectives are used to establish a possible sequence of destinations for human explorers, with the ultimate goal being human exploration of Mars. The report describes the societal and scientific imperatives for human space exploration, identifies a set of useful and achievable destinations, establishes architectural principles that can be used to guide trade studies and identify options, and develops a notional exploration scenario that exemplifies an evolutionary, stepping-stone approach to human expansion into the solar system. We focus on space exploration as a scientific and public endeavor; commercial objectives for human space activities are outside the scope of this report. Furthermore, we do not attempt to propose technical designs nor to estimate costs or prescribe schedules, but instead focus on identification of requirements that provide context for future more detailed technical studies.

The study that formed the basis for this report was chartered by the International Academy of Astronautics and conducted on a volunteer basis by a small number of individuals, independent of any government space agency. It is not a strategic implementation plan for any national space program; rather, it is intended to be a vision for the future that can be considered by interested space agencies, hopefully in the context of an international cooperative endeavor. This study represents a mere sampling of the scientific opportunities and exploration options, and does not constitute a comprehensive plan for space science and exploration. We recognize that there are many possible pathways through the solar system and that they will evolve significantly over time; this report represents an example of what *could* be done, not a prescription for what *will* be done.

Destinations

Since the end of Apollo, the lack of a clear destination and an easily understood purpose has been a major hindrance to human space exploration. An architecture must be developed within which logical and compelling destinations serve as stepping-stones into the solar system. Today the imperatives of science and exploration, rather than politics and competition, provide the context for determining where and how human explorers should go, and this in turn will allow us to build capabilities and infrastructure in an evolutionary fashion.

The exploration imperative, scientific goals, and technical and programmatic considerations lead us to the following destinations:

- *The Moon:* Its proximity to Earth makes the Moon an important step beyond Earth orbit. Human explorers will conduct scientific research, identify and develop resources, gain experience with establishing human outposts on other planetary bodies, and validate techniques for exploration of more distant destinations.

- *Sun-Earth Libration Point L2:* This point in deep space is a preferred location for future constellations of space telescopes. Human capabilities for assembly and servicing will enable revolutionary observations of the Universe and extra-solar planetary systems. In the process we will learn to live and work intensively in space. This location is also an energy-efficient “gateway” to other destinations.
- *Near-Earth Objects:* These small bodies represent the most significant Earth impact threat, are scientifically important in their own right, and represent potential resources for further exploration and exploitation. They also provide an ideal intermediate deep-space destination on the path to Mars, since much of the infrastructure developed for earlier destinations can be utilized with modest extensions.
- *Mars:* For its scientific value as well as for its enduring place in human consciousness, Mars is the ultimate destination for humans in the next 50 years. When approached in the context of a set of destinations, each compelling in its own right, exploration of Mars represents the natural culmination of a sustainable program of human expansion into the solar system.



Human exploration of Mars can best be achieved in the context of a flexible, evolutionary architecture.

Architecture

In a realistic long-term space exploration program, humans must proceed to new destinations at a gradual and deliberate pace, using the experience gained at each step to enable them to proceed safely and efficiently to the next. In this way, capabilities can be developed systematically to provide a more effective, affordable, and sustainable space exploration program. The enduring historical legacy of the U.S. Apollo Program is the stunning accomplishment of landing on the Moon, but it also serves to demonstrate the lack of sustainability of a politically motivated program with a singular national objective that, once accomplished, provides no basis for continuation. More appropriate for today is an alternate vision driven by the fundamental benefits and public allure of space exploration, within which an international enterprise can build a permanent human presence in the solar system. This architecture features gradual and systematic establishment of new waypoints at ever more distant destinations, with the ultimate goal of enabling human exploration of Mars in the first half of this century.

The current U.S. Space Shuttle and International Space Station (ISS) programs have become unduly complex and costly and, as a result, have had difficulty maintaining the broad constituency required for sustained financial support. In a new architecture, it is crucial that any waypoint on the road to deep space does not become a stumbling block, for this will bring the vision to a halt. Each step should be viewed in the context of a permanent human presence in the

solar system and should contribute to the ultimate objective. Highly visible milestones must regularly be accomplished to provide clear evidence of progress and to maintain support. While a general timeframe is necessary for program planning, there need be no firm date commitments beyond the current step in the architecture. The program should proceed as technical progress and scientific discoveries dictate, and only as fast as the international political process and budgets allow.

The architecture we derive has several important attributes. First, it represents a stepping-stone approach with exploration of Mars clearly established as the ultimate goal. Each intermediate destination is selected for its scientific value as well as for its logical place on the road to Mars. Next, crew and cargo transportation functions are separated; this helps to minimize human flight time and other risk factors, and obviates the need for new and costly propulsion technologies or launch vehicles during the early stages of this architecture. Intermediate destinations can be inserted or deleted as dictated by funding, scientific or technological progress, risk management, and political factors. Our goal is to establish an architecture in which only one major new development is required to enable the program to reach each successive destination (coupled, of course, with evolutionary improvements in established capabilities). These principles lead to a robust architecture that is consistent with a permanent and scientifically beneficial human presence in the solar system; it may not be the fastest road to Mars, but it is one that is justifiable, affordable, and sustainable.

This architecture considers in-space transportation and destination operations only. We assume low Earth orbit as the starting point and do not address Earth-to-orbit transportation, which is presently the subject of intense study. We further assume that issues of astronaut health and safety will continue as a research focus of the ISS and related ground-based studies, and that it is ultimately determined that human flight in deep space for extended periods is feasible. The technical solutions that are devised for these health and safety issues (e.g. artificial gravity) will have a significant effect on the final design of any crew vehicle for deep space transportation, and we do not presume to be able to contribute to those solutions in this brief study. The early destinations in this architecture have the benefit of substantially shorter flight times and will provide platforms for further research into the biological aspects of human space flight.

Finally, we assert that any such long-term human space exploration program must be a truly international undertaking. This represents the expansion of the human species into the cosmos and thus must be conducted by the people of planet Earth, not by any individual nation or limited alliance. The capabilities and priorities of the international participants will have a major effect on the overall architecture and on the pace at which it proceeds.

Robotic and Human Scientific Exploration

In the course of the space program, the debate over the relative merits of robotic and human exploration has proven more distracting than productive. The fact is that both enterprises have co-existed and even cooperated during this history and both have produced remarkable achievements. The fear that the large cost of human space flight might overwhelm robotic space exploration has not materialized. In fact, support within the U.S. space program for robotic scientific exploration has grown over the last decade because the program has well-articulated goals, is highly successful, and is carrying out important scientific missions that are popular with the public.

Early robotic missions played a crucial role in both the Soviet and American lunar exploration programs, paving the way for Apollo. Similarly, robotic Mars missions have recently begun carrying investigations important to the future human space flight program. Clearly the role of robotic missions as precursors to human exploration is well established. By the same token, the human space flight program has already made important contributions to robotic space science, perhaps the most visible being the Hubble Space Telescope servicing missions carried out by the Space Shuttle. That example alone is enough to demonstrate that human capabilities for assembly and repair can greatly enhance science return, and it is likely that they are only going to become more critical as robotic platforms become more sophisticated.

In this study we adopt the philosophy of a fully integrated exploration program that utilizes robots *and* humans, not robots or humans. We assume that a robust robotic exploration program continues, focusing on the appropriate scientific objectives and gathering data that will help to enable human exploration. When a decision is



Robots and humans have been and will continue to be partners in space exploration. Here Astronaut Pete Conrad inspects Surveyor 3 on the lunar surface.

Robotic and Human Exploration

An excellent analysis of the relative merits of robotic and human explorers, and their optimum mix, is given in the U.S. National Research Council report on Scientific Opportunities in the Human Exploration of Space (1994). The report concludes that humans are ideally suited to intensive field study and other such tasks requiring complex physical articulation, expert knowledge, and adaptability. Where real-time iterative observation and re-planning are necessary, the more cumbersome, delay-ridden methods of remote control are ineffective. Humans have advantages over robots for serendipitous discovery and response. Robots are inherently expendable (although at some cost) and must be used where risks to humans are unacceptable. Robots should be used where there is no clear advantage to using humans and for performing repetitive, tedious tasks. Humans will always be limited by safety considerations, the necessity for spacesuits, limited mission durations, time required for routine maintenance, and the cost and mass of human life support systems.

The decision to proceed with human exploration will not be made on scientific grounds alone. Science should provide part of the basis for such decisions, however, and human exploration should provide an opportunity for unique science. The NRC report states “Robotic options should be used until they provide enough information to ... define a set of scientifically important tasks that can be well performed by humans *in situ*...It cannot be demanded that these tasks be best and most cost-effectively performed by humans.”

made to send human explorers to a given destination, robotic missions will be used to help emplace assets and prepare a rudimentary infrastructure. These “robotic outposts” will be later occupied and utilized by human explorers. This exploration strategy calls for the use of robotic means for reconnaissance and scientific exploration to the full extent that robots can accomplish the desired goals, with human capabilities being applied where they are most valuable. During human occupation, robots will provide support and become sensory extensions and tools for human explorers, and human capabilities will be used to build, repair, and deploy robotic explorers to optimize the overall scientific return.

Clearly the rationale for building a permanent human presence in deep space goes beyond science. Human space exploration is essentially a societal enterprise, and is motivated in large part by the “exploration imperative”—the innate drive of human beings to extend their boundaries and explore the unknown. Our robotic explorers will be critical partners in this expansion and their capacity for scientific investigation will continue to grow, but they will never approach the capabilities of the human mind. And they will never fully satisfy the intrinsic human need to actually *go someplace!*

The 21st Century Space Frontier

Throughout human history, the desire to explore the unknown has been perhaps the greatest single force driving progress and invention. Much has been written about the nature and genesis of this apparently instinctive characteristic of the human species. Its motivations have been ascribed to many factors, among which are: self-preservation and the need for larger territories as the population expands; fear of the unknown and the desire to ensure security; curiosity and the hope of understanding the overall context in which we live; and the desire for wealth and power. For our purposes, it is not important to establish the sociological or evolutionary foundation for this innate drive to explore, but it is important to acknowledge that it exists. It convinces us that, in spite of the obvious costs and risks, there will eventually be established a permanent human presence elsewhere in the solar system. In fact, it is virtually impossible to conceive of a future in which humanity would never make a serious attempt to expand beyond its home planet.

The challenge and the allure of space exploration are undeniable. At the beginning of the 20th Century the great public adventures were exploration of Earth's polar regions and the challenge of powered flight. No one in 1900 could have dreamed it possible that in less than a century anyone would be able to fly in comfort from Paris to New York in about six hours. Similarly, at the beginning of the 21st Century our exploration challenge is that of space travel. We have the ability to fly to low Earth orbit but can only stare hopefully beyond; in what is surely one of history's major anomalies, we traveled to the Moon and back 35 years ago but are unable to do it now. But we have certainly not retreated to terra cognita to remain forever. History leads us to predict that, by the end of the 21st Century, travel to Earth orbit and perhaps to the Moon may well be as commonplace as air travel was at the end of the 20th Century. We cannot predict the particulars, just as the Wright Brothers in 1903 could not have imagined a jet airliner. But we can prepare for the possibilities by establishing goals, objectives, and benefits, and by examining the possible pathways that this inevitable development might take.

Historical Perspective

Arguably one of the most astonishing developments in human history is the rapidity with which the space frontier has been opened. Although contemplated for decades before, the direct roots of this process go back just to the first half of the 20th Century and the advent of regular air travel. Only now are we celebrating the centennial of powered heavier-than-air flight...yet already humans have been to the Moon and back, and our robotic extensions have explored much of the solar system and are venturing into interstellar space. Considering the technological barriers that had to be overcome, the pace of this development is amazing. By reviewing some of the noteworthy accomplishments that have epitomized human attempts to get off the surface of Earth, we hope to provide some context for discussion of the next major steps. It is relevant to note at the outset that many of these achievements were motivated initially by curiosity, but sustained and developed mainly through competition and the need for security.

Early 20th Century Flight

The Wright Brothers and other inventors around the world sought to get human-carrying machines into the air, point them in a direction, and go someplace. For a decade a whole menagerie of rudimentary flying machines took wing, but aviation really came into its own with the continental-scale conflict in Europe between 1914 and 1918. It was then that aircraft became a useful and even a necessary element of military capability. There followed 20 years of slow but steady progress in air travel, highlighted by Lindbergh's daring solo crossing of the Atlantic and the growth of commercial aviation. Meanwhile, early designers and experimenters—Tsiolkovsky, Oberth, Goddard, and others—worked out the fundamentals of rocketry in Europe and America.

These rockets had obvious military applications, but the inventors were motivated more by curiosity and by the draw of a first-ever achievement—could they do it? For example, Robert Goddard's early paper was titled simply "A method of reaching extreme altitudes." These visionaries believed that humankind could travel to other planets using new developments in rocket propulsion, but their dreams became reality only much later, after World War II created the technological catalyst for controlled rocket flight and laid the groundwork for deep-space propulsion.

Mid-Century Technology

Aviation was greatly accelerated by the catastrophe of World War II. The Englishman Frank Whittle patented the jet engine in 1930, and shortly thereafter Germany developed the first military jets and employed them at the end of the war. Following the war, these technologies moved rapidly into the civilian sector. Jet transports, first by de Havilland, then by Boeing, Douglas, Convair, Sud-Est, and Tupolev, simultaneously shortened air travel times and lowered costs—an unbeatable combination.

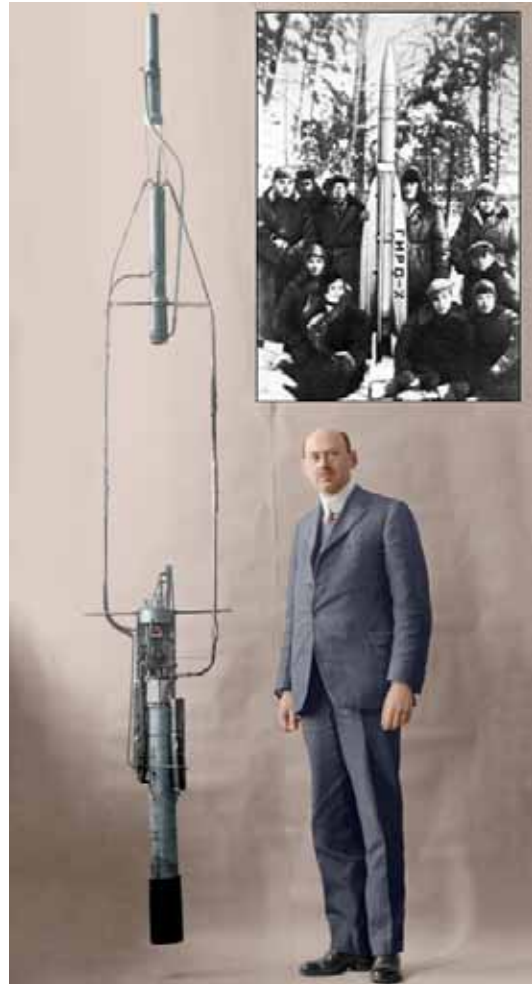

Pioneering achievements in rocketry came from dedicated individuals working initially without any significant government interest. This is Robert Goddard with one of his early inventions; the inset shows an early Russian club rocket.



Major technological advances resulted from the large investments made by the military. This is a launch of a German V2.

Rocketry also surged during the war. Germany developed and successfully used the first rocket-propelled weapon, the V-2. After the war, both the US and USSR built on this technology to construct their own military rockets. Captured German V-2s were also pressed into scientific use, exploring the far upper atmosphere and the edge of space. The month following cessation of hostilities saw a launch in the US to 70 km, a record at the time. An unintended but fortunate byproduct of aviation's growth was the creation of an infrastructure—skilled personnel, technologies, and facilities—that allowed rapid movement into the space age. When the time came to build spaceships, there were men and machines that could do it.

With the world free from the exigencies of war and with startling new technologies in hand, it was possible to think realistically about the possibilities for space travel. In 1952 the event that was to define the opening of the space age was still 5 years away, but Americans were treated to a vision of space exploration articulated by Wernher von Braun and beautifully illustrated in Collier's magazine. In the 1950s, Americans learned about world events from newspapers, movies, early television and national magazines like

Life and Collier's. These magazines reached the homes of almost everyone. Von Braun's vision was splashed on the covers of five issues of Collier's and lavishly illustrated on dozens of pages in each one.

"Man Will Conquer Space Soon" trumpeted the headline and image on the cover of Collier's on March 22, 1952. "Man on the Moon" ran the headline in the October 18, 1952, issue. The painting on that cover illustrated a piloted landing on the lunar surface and bears a vague resemblance to the actual landing that was to come in 1969. In fact, the techniques that were ultimately used to accomplish the lunar landing were very similar to those described in the articles 17 years earlier. This vision so captured the American public that Walt Disney created a whole series of animated shows in 1954, based on the Collier's articles and the technical advice of Werner von Braun. Just about everyone in America with a TV set watched the Walt Disney show every Sunday night in 1954, and this wonderful vision of exploring space was brought alive for them. Engaging the public in this way no doubt created much of the support that was necessary when the Soviets snapped this dream into the realm of reality three years later.

The lay American audience was fascinated by the idea of space travel as explained by individuals who had succeeded at such impressive – albeit originally hostile – technological feats. To the person on the street, rocketing through space on a grand scale appeared to be both achievable and understandable. It was in this era that the popular seeds were planted for human travel in space, and when the space age opened in 1957 there resulted the biggest rush for entrance into science and engineering colleges in American history.

From Sputnik to Apollo

While the Americans paraded dreams of spaceflight in front of their public, the Soviets were working in secrecy on their own ambitions. The counterpart to Werner von Braun in the USSR was Sergei Korolev, whose name and role was a state secret. Like von Braun he harbored the same dreams of space exploration and developed his rockets in the service of the national military. Korolev was responsible for the development of the first Soviet ICBM and the space spectaculars, both robotic and human, enabled by that vehicle.

The Space Age opened on October 4, 1957, with the launch of Sputnik early in the flight test program of Korolev's ICBM. The Soviet leadership was surprised at the alarmed reaction in the West and took full advantage to proclaim it a symbol of socialist dominance. This inexorably led to the great Space Race in which the US started far behind. The Space Race was a public display of the secret ambitions to build the military rockets that ultimately provided access to space.

Most of the history of space exploration in the 20th Century was characterized by intense competition between the USSR and USA for dominance in military rocket technology. At the dawn of the Space Age, Europe and

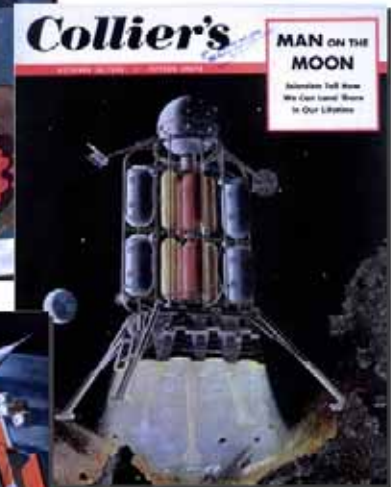

The American public was thrilled in the early 1950's by Werner Von Braun's fantastic, illustrated vision of space exploration.



The "shock heard 'round the world" that initiated the Age of Space Exploration: Sputnik.

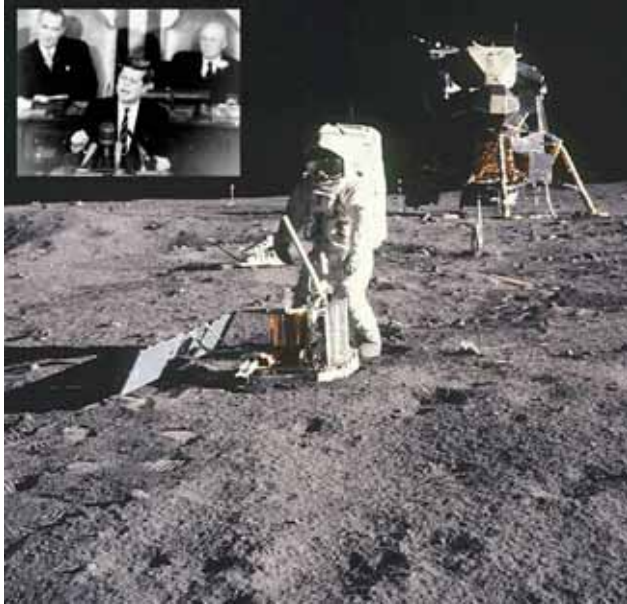

The Cold War provided the backdrop for President Kennedy's challenge to America and the world. The American-Soviet "Space Race" culminated in the first landing on July 20, 1969.

Japan were preoccupied with rebuilding their nations after the devastation of World War II, while the USSR and USA were developing their ICBMs. The first human space flight was also Soviet: Yuri Gagarin's orbital flight in April 1961. These events shocked Americans, who recognized immediately the implications for their national defense. The USA mobilized a massive space development program of its own in 1958, and in 1961 President Kennedy formulated a national goal to land a man on the Moon and return him safely to Earth. With the technical and popular foundation laid by von Braun, Collier's, and Disney, Kennedy's pronouncement enjoyed widespread support in America.

The Soviet Union responded to Kennedy's clear and open challenge and initiated a competing national program to send a cosmonaut to the Moon before the Americans. Initially the race to the Moon

appeared to be neck and neck. The Soviet Union produced small robotic lunar impactors, flybys, landers, orbiters, along with increasingly ambitious human space spectacles in Earth orbit and unpiloted circumlunar test flights of a Lunar Soyuz capsule. The U.S. moved through the Mercury and Gemini programs in parallel with unmanned Ranger hard landers, Lunar Orbiter missions, and Surveyor soft landers. Side attractions included the race to planets with the first probes to Venus and Mars in the early 1960's. All this culminated with the events of July 20, 1969, and Neil Armstrong's famous words, "Houston, Tranquility Base here; the Eagle has landed".

Having lost the race to the Moon, the USSR abandoned its ill-fated N-1 Moon rocket and conducted highly successful robotic lunar rover and sample return missions through 1976. The Americans shut down their Apollo lunar program in 1972 after six successful flights to the lunar surface. Serving to reinforce the political motivation of the Apollo program is the fact that it was not until the final flight, Apollo 17, that the crew included a practicing scientist.

Just as the international air races in the first half of the 20th Century helped to stimulate the development of aeronautics, the Space Race in the second half of the century resulted in an explosion of space-related research and technological development. While competition in space exploration between the USSR and the USA originally focused principally on flying humans to the Moon, both countries also sent robotic spacecraft throughout the solar system, resulting in enormous strides in scientific knowledge and spaceflight capabilities. It is highly unlikely that the large national investments required for this progress would have been made without the political imperatives of the Cold War.

Post Apollo Letdown

Many thought that space exploration would follow the course of aviation and continue at the breathtaking pace of the first dozen years. Some projected imminent routine flights to the Moon and tourist hotels in Earth orbit. Impetus was added by films such as Stanley Kubrick's classic "2001: A Space Odyssey."



Many of the grand early visions were not realized. The Cold War passed, and human space exploration retreated to Earth orbit in limited but expensive facilities.

Others realized that the space race was over and that the driver that had fueled those heady accomplishments in human spaceflight—East-West competition for geopolitical dominance—had moved elsewhere. In America, attention turned away from space exploration to issues such as the war in Vietnam and the resulting domestic turmoil. Human spaceflight suffered partly from a dearth of noteworthy accomplishments that could capture headlines, but mostly from the lack of a clear, coherent goal that could be perceived as a suitable successor to the great race to the Moon.

Space flight was occasionally shown to be a tool for international cooperation, as with the Apollo-Soyuz test flight, and was touted as a general stimulus for development of advanced technologies and consumer products. Finally the U.S. settled on building a reusable vehicle that could be flown frequently, at low cost, and would replace nearly all other launchers. The resulting Space Shuttle, of course, has fallen far short of those expectations. And the Space Shuttle had significant ramifications for the scientific exploration of space in that its development problems, delays, and cost overruns resulted in suspension of NASA's robotic deep space mission launches for nearly the entire decade of the 1980's. In the meantime, the Soviets moved aggressively in robotic exploration with the Vega and Phobos missions, and in human space exploration with continued Earth orbital flights and launch of the Salyut and Mir space stations.

What was to become the International Space Station was started in the mid 1980's as "the next logical step" in the human exploration of space, but unfortunately that vision has not been carried to its logical conclusion. Eventually the U.S. human space flight program evolved into an element of international policy, first with traditional Western allies and then by bringing in Russia as a full partner. Although justifiably advertised as a unique scientific laboratory, logistical and financial burdens have prevented the ISS from fulfilling its oft-stated potential for revolutionary scientific discoveries. Indeed, the tragic loss of the Space Shuttle Columbia has called into question the future utility of both the Space Shuttle fleet and the ISS.

Robotic Exploration Surges Forward

While human space activity retreated to Earth orbit after the race to the Moon, progress continued to be made in dramatic fashion through robotic space exploration. Venus and Mars were visited many times by Soviet and American orbiters and landers with varying degrees of success. The 1976 Viking landings on Mars, along with the spectacular Voyager missions to the outer solar system that followed shortly thereafter, at the time represented the most impressive and ambitious accomplishments ever in robotic spaceflight. Twenty years after Viking, humankind returned to Mars with Pathfinder and its companion Sojourner, the first rover on Mars. Widespread interest in the antics of that little robot proved how fascinated the public still is with space exploration. With images transmitted in near real time over the Internet, the number of people tuning in was a world record. During the summer months of 1997 over a billion people followed its exploration—more than attended all of that summer’s blockbuster movies combined. That was the beginning of an intensive program of robotic Mars exploration that continues today and has been extremely productive, leading to the widespread belief that Mars may have possessed liquid water and a habitable climate in its past. This has intensified the scientific debate and speculation on the possibilities that life may have developed on Mars and that it may persist today, perhaps hidden just beneath the surface.



While human exploration languished, robotic exploration blossomed and provided the public with visions of new worlds. Mars Pathfinder demonstrated to a new generation that Mars is a place worthy of intensive exploration.

Today, focused on the desire to understand the development of life and habitable environments, robotic space science and exploration is more vigorous than ever and has become a truly worldwide endeavor. Fifteen nations have joined to form the highly successful European Space Agency (ESA). Among their early achievements was the Giotto mission’s close encounter with Halley’s comet, which was successfully coordinated with similar missions sent by Japan and the USSR. There are several current examples of successful international cooperation on robotic missions, including the joint NASA/ESA/ASI Cassini-Huygens mission now preparing for arrival at Saturn and Titan in July 2004. ESA has successfully launched its first-ever mission to a planet, Mars Express, which is now orbiting Mars and in which many countries are participating. Japan has an ambitious sample return mission en route to a near-Earth asteroid and is preparing two complex robotic missions to the Moon. India is preparing a lunar orbiter for 2008. And China has recently inaugurated its Earth-orbital human spaceflight program at the same time that it is considering sending robotic missions to the Moon. Other countries are preparing to take their own steps into space. International participation on robotic space science missions is now the rule rather than the exception.



During the 1980's, nations other than the USA and Soviet Union embarked on robotic exploration missions. This photo of the nucleus of Comet Halley was taken by Europe's Giotto mission in 1986, as part of a coordinated international campaign to study the comet.

Lessons from the Past

Throughout the 20th Century, government played a key role in the development of aeronautics by funding early research and development, thus attracting investments that enabled commercial flight to advance and flourish. In the space industry, this has been done through work at government laboratories and at the large aerospace companies spawned by the first six decades of aeronautics development. One stimulus initially used early in the 20th Century and now being adopted by NASA is the use of incentive awards or prizes for specific targeted achievements; today's best-known example is the privately-offered "X-prize" for low-cost suborbital human space flight. The demonstrated principle is that government should fund and provide incentives for research and development, but should then purchase the resulting services from the private sector. *The enterprise must be supported by government investment in research and development, and by purchase of commercial services and operations.*

The last thirty years of history demonstrate that there is unlikely to be another Apollo-type funding spike for any new space exploration initiative. Development of the capability for human exploration beyond Earth orbit will take a sustained level of funding over a period of decades. This must be viewed not as a development project with a single defined objective, but as an investment in a capability to be funded at an annual level that grows at least with inflation. Government is the only entity with the resources necessary to initiate large exploration enterprises such as Apollo, Space Shuttle and the ISS. Today, moving human exploration beyond Earth orbit is of the same order of magnitude and even longer term. Unlike single-flight-element programs such as Apollo, Space Shuttle, and the ISS, which are limited to one

destination, the establishment of permanent human presence in the solar system is open-ended, requiring a series of flight system developments compatible with multiple destinations. The capability must be designed to evolve over a large number of years, and cannot be dedicated to production of a single flight system with a targeted first flight date. To achieve this it must be able to respond to discoveries and technical advances, and to the changes that inevitably occur over long development time periods. *The enterprise must be affordable, sustainable, and flexible.*

Finally, *the enterprise must have clear, concise, and well-articulated goals.* Apollo and today's robotic space science and planetary exploration programs demonstrate that clear and well-understood goals can capture and maintain public interest and support. The Space Shuttle and ISS, on the other hand, were built to provide launch and space research services to an inappropriately wide range of customers for unclear long-term reasons, and they have proven unsustainable. This report provides a vision for an international human space endeavor that has clear goals and a strong scientific underpinning, in the expectation that these will result in an affordable, flexible, and sustainable human spaceflight program buoyed by strong public and governmental support.

The Imperatives: Why We Explore Deep Space

There are cultural, scientific, and political imperatives that contribute to the drive to explore space. The cultural imperative is embodied in the innate need of humankind to extend its boundaries and move forward into new domains, in the process gaining a sense of progress and common accomplishment. This urge to explore and advance seems to flow from a survival instinct that is basic to the human species. The scientific imperative derives from humankind's desire to understand its surroundings, whether to satisfy natural curiosity, gain material benefit, or dispel fear of the unknown. This may be another manifestation of the same fundamental characteristic of human nature, since scientific thought, observation, and experimentation are well documented throughout recorded history. We now know that certain fundamental and compelling questions of our origins and destiny can only be answered by observing phenomena in deep space and by studying the environments of our solar system.

However, to this point in human history neither the cultural exploration imperative nor the scientific imperative has proven sufficient to sustain human exploration beyond Earth orbit. A commercial imperative, the ability for private citizens to make money in space, has also thus far proven elusive; the advent of space tourism represents the latest and perhaps the most promising attempt to change that. The only imperative shown thus far to be sufficiently compelling has been the political, as embodied in the Apollo expeditions to the Moon. The need to demonstrate and project national power and pride created the Space Race in the late 1950's; the vitality of the world's first national space programs can be traced to this single driving force, all others having been of secondary importance at best. As we have seen, though, when this "competition" ended nearly a quarter century ago, much of the national willpower that sustained the early human spaceflight programs disappeared with it.

How, then, do we begin to establish a new paradigm of vigorous human exploration of the solar system? We must begin by re-examining the imperatives and by acknowledging that in today's environment, all three of them—cultural, scientific, and political—must exist together to provide sufficient impetus for the investments and willpower that will be required. We must clearly articulate the unique opportunity that has been afforded this generation by the confluence of scientific discovery and technological progress. This will provide a basis for definition of the destinations and activities of human explorers. We must emphasize the cultural value of exploration by identifying meaningful “first ever” achievements and by building in a sense of physical progress into the solar system. Finally, we must develop a realistic long-term architecture that is evolvable, flexible, and affordable, and which by engaging many nations provides a unifying context for long-term international cooperation.

To Understand: The Scientific Imperative

The early human spaceflight programs, up to and including the Apollo missions to the Moon, made no pretense about being scientifically motivated. They were technologically driven as part of a race between the U.S. and the Soviet Union, and science was a secondary or tertiary consideration at best. When the race was over, the lack of a compelling scientific foundation or a recognizable long-term goal led to a drastic reduction in public interest.

In comparison to that of forty years ago, today's society is remarkably scientifically and technically sophisticated. The explosion of information and communications technologies has placed vast amounts of information at the fingertips of virtually every interested citizen. And while much of the public generally accepts the notion that scientific discovery and exploration are a worthy human imperative, the public also has become more skeptical and more demanding of clear articulation of goals and benefits. An indication of what these goals should be can be found in the continuing intense public interest in discovery-oriented robotic space science programs, such as the Mars Exploration program and the observations of the Hubble Space Telescope. To gain the public's advocacy, the scientific challenges we undertake should be bold and clear, and should resonate with fundamental human questions. Fortunately, our understanding and capabilities have progressed to the point that we can make meaningful progress toward answering questions that are worthy of public support, such as “Where do we come from? What will happen to us in the future? Are we alone in the Universe?” These very fundamental issues can be recast as scientific goals to be achieved in the course of exploring space. And from these goals we can formulate objectives and investigations, identify destinations, make architectural trades, and develop a compelling integrated plan for robotic and human exploration.

Where did we come from? Humans are an integral part of the Universe and the product of a long trail of cosmic evolution. In the first step, the original matter and energy of the Big Bang condensed into stars, inside of which primordial hydrogen atoms were cooked into heavier rock- and life-forming elements such as silicon and carbon. These new elements were returned to the interstellar medium by stellar explosions, where they were incorporated into succeeding generations of stars. Planetary systems, some containing terrestrial planets made of rock, formed around some of these new stars.

The surfaces of these planets came to be painted with a veneer of the more volatile organic compounds made from life-forming elements. Under conditions that have yet to be understood, this chemical veneer was transformed into a biological infestation that, over billions of years of planetary evolution, ultimately became intelligent life. We are driven to understand this process by which we came to be here, and to learn what it can tell us about our place in the Universe.



What will happen to us in the future?

Before the Space Age, the solar system and the Universe beyond were largely unknown territory. The sky above us was a horizon into which we could see only dimly, with a combination of wonder at its beauty and fear of the unknown. Within just a decade of the dawn of space exploration, it became clear that space is not just a painted backdrop: it is an active environment within which we can learn much about our planet. It can also be a violent place and contains objects that are real threats to Earth. We seek to understand these threats and how we might mitigate them, to learn how planets evolve so that we might predict the future of our own, and to understand our destiny both on our home planet and within the frontier of the solar system.

Are we alone in the Universe?

This is perhaps the most basic question that has faced humanity since people began contemplating the night sky. Some have found comfort in the notion that we should be alone; some cannot believe it could be so; still others are fearful of the potential for other life in the cosmos. We are almost certain now that there is no other intelligent life in our solar system. But advances in biology have revealed the startling robustness of life on our planet, and we now recognize that microbial life may



well have developed elsewhere in the solar system. And if life, regardless of its form or amount, is found in our immediate planetary neighborhood, then the implications for the likely commonality and diversity of life throughout the universe are monumental. For the first time in history we possess the means to search for evidence of life in our solar system and beyond, and this great quest will serve to motivate and organize much of what the world will achieve in space.

To Explore: The Cultural Imperative

Human beings are explorers by nature. Lacking any particularly outstanding physical or sensory apparatus to survive in a violent Nature, humans have survived only through intelligence, adaptability, and the ability to take advantage of new opportunities. The exploration of space is the present-day manifestation of this drive to expand the frontiers of human influence and experience. While national defense, power, and pride were the original impetus for government funding, basic human curiosity, imagination, and the desire to explore have been at the root of the public's interest in space exploration.

Human exploration has always been defined by its destinations. Whether they were in search of wealth, new lands, or easier access to known lands, the explorers of the past generally had a destination in mind, even if their routes didn't take them precisely where they hoped or expected to go. Modern-day explorers have had destinations too—the Antarctic, the deep ocean, the Moon—and our robotic explorers have journeyed to the most fantastic destinations in the solar system. For the explorations of the future to have the same urgency and impact, they must likewise be targeted to exciting and meaningful destinations. The planet Mars is the destination that will be the most compelling to humankind in the foreseeable future; it occupies an undeniably unique place in human history and human consciousness, and will represent perhaps the ultimate triumph of human ingenuity in this century. Mars is a very challenging goal, however, and to reach it in a safe and affordable manner we must identify intermediate destinations that are more amenable to our capabilities and annual budgets, and that will allow us to advance gradually and systematically outward. Fortunately the solar system has provided us with well-placed stepping-stones that form a natural pathway to Mars.

Our ability and our will to explore space is both a gift from the explorers of the past and our legacy to future generations. Space exploration will not only fulfill the exploration imperative, it will stimulate the development of new technologies and new industries that feed the economy and enhance security in ways that cannot be anticipated. It will create highly skilled technical jobs, hasten development of a knowledge-based society, and enhance education, innovation and entrepreneurship.

To Unify: The Political Imperative

In the early days of the Space Age, the political imperative was primarily divisive. It served to accentuate the differences among competing nations, and any cooperation was used sparingly and primarily as a political tool. At the time, space exploration was powerfully symbolic and the possibility that a nation could exploit space to military advantage was taken as a very serious threat. While this obviously represented a powerful incentive for expanded national space programs, the resulting commitment was transitory: as soon as the political situation changed, investments in space exploration diminished and it ceased to have the same national importance and impact.

Today space exploration can be seen in a much more positive and hopeful light. The benefits of close cooperation have been made clear on numerous robotic missions. International crews have been aboard the Space Shuttle many times, and the Mir Space Station has hosted space explorers from many nations. As the International Space Station continues to develop, hopefully the joint development and utilization model on which it is based will also prove successful. The human exploration of space, limited in scope though it is today, is being shown as a global endeavor without impenetrable national boundaries. It has unique potential to be a unifying endeavor that can provide the entire world with the opportunity for mutual achievement and security through shared commitment to a challenging enterprise. Just as the development of powered flight and global air transportation in the 20th Century created new economic opportunities and ultimately connected societies all over the planet, so too will the exploration of space create new opportunities and stronger international bonds in the 21st Century, in ways that we cannot anticipate today.

We take it as a given that the future human exploration of the solar system will be an international undertaking. Obviously we cannot specify today which nations can or should implement which elements of the program. We can, however, identify models of international cooperation that can help advance the overall development of a multi-national exploration program and that might provide context for productive future discussions.

Science

The nature of science is to provide understanding. The scientific imperative for space exploration stems directly from universal human questions about our origins and our destiny; these pose a challenge to science and they can be translated into a set of long-term scientific goals for space exploration. These science goals, like the questions themselves, are broad and comprehensive, so that for each goal it is necessary to define an approach consisting of a set of specific objectives that can be met through the scientific exploration and exploitation of space. The objectives define the destinations where scientific investigations must be conducted, and provide the basis for an orderly approach to exploring and utilizing the solar system. The first step in our architecture is to trace the logic from each fundamental question to science goals and then specific exploration objectives.

Where did we come from?

This question requires us to contemplate the very nature of our existence. Even so, the space program can provide an approach to begin to answer it. Astronomers can address the question by investigating how the universe began and evolved, and by learning how galaxies, stars, and planets formed. Planetary scientists can study how planets are formed from evidence preserved in the most primitive bodies in our solar system, and perhaps from bits of the newly formed Earth deposited or lightly buried on the Moon. The seminal event on the young Earth was the advent of biology, and geobiologists are already conducting field and laboratory research into how life originated on the young Earth and how this biological veneer evolved with the planet to culminate in the human species after 4 billion years. From this we derive two key scientific goals to address this question.

Goal 1: Determine how the universe of galaxies, stars, and planets began and evolved.

To achieve this goal we must observe the universe across the entire electromagnetic spectrum, and to its very beginning, to study the dynamic processes that created the galaxies, stars, and attendant planetary systems that comprise the universe. The tools for this work will be future advanced space observatories, the precedents for which are the current Great Observatories—Compton Gamma Ray Observatory, Advanced X-Ray Astronomical Facility, Hubble Space Telescope, Spitzer Infrared Telescope Facility and their European counterparts ISO Infrared Space Observatory, XMM-Newton X-ray Observatory and Integral Gamma Ray Observatory. The ideal location for these new space observatories will be the Sun-Earth Libration Point L2 (SEL2). A key task will be to make observations of the youngest stars in various stages of their early lives in order to gain an understanding of the process of planetary system formation. Planetary scientists will need to examine the smallest and most primitive bodies in our own solar system—asteroids, comets, and Kuiper-Belt objects—for clues to how planets are assembled and disrupted early in their history and the extent to which they contain the primitive organic material necessary for the origin of life. This is essential for understanding how terrestrial planets originate and how prevalent they may be in the cosmos. The most accessible of these primitive objects are the Near-Earth Objects (NEO's).

Objective 1.1: Survey matter in the universe across the spectrum and to beginning of time.

This objective requires subdivision of the observations into manageable elements and construction of advanced facilities to accomplish them. To understand the origin, evolution and ultimate destiny of the universe requires an understanding of the history of the distribution of matter and fields in the universe, particularly of the matter that is currently detectable—galaxies, stars, planetary systems, dust, and gas.

This science can be addressed through a combination of ground and space based astronomical observatories operating across the spectrum from gamma rays into the radio. Gamma- and X-ray telescopes examine the high-energy objects in the universe, such as quasars, supernova remnants and black holes. They require a much different aperture technology than optical instruments. Ultraviolet, optical, and infrared instruments examine large structures such as galaxies, condensed matter such as stars, and nebulae filled with dust and gas. The far infrared and radio can see through dust into the atomic and molecular matter distributed through the galaxies.

Our Eyes on the Universe

Large aperture is the key to all astronomical observatories. This can be achieved by monolithic, single aperture telescopes such as the Keck 10-meter optical/infrared telescope in Hawaii, or by coherently combining the output of multiple apertures. Lower frequency sub-millimeter and radio telescopes are much easier to couple coherently than those at higher frequencies. The technology for coherent combination of optical frequencies has only recently been developed and is being tested on the twin Keck telescope facility. There are scientific roles for apertures of all types; short focal length single apertures for wide angle surveys, long focal length single apertures for higher angular resolution and deep observations, and coherent arrays for very high angular resolution. Constellations of spacecraft for making coherently coupled multiple aperture space telescopes are a technology now being developed from the X-ray to the far infrared.

Space observatories have the distinct advantage of operating above the absorbing and distorting effects of Earth's atmosphere. HST has demonstrated the power of even a relatively small aperture telescope in space, but future space observatories will require much larger apertures. These can be built on Earth but suffer even more from atmospheric distortion. Aperture size scales with wavelength for constant angular resolution, so that a 1 km aperture is required in the far infrared to achieve the same angular resolution as the 2.4-meter HST. Fortunately, it is generally easier to construct larger apertures for lower frequencies. A radio telescope requires only an open mesh antenna with figure quality measured in centimeters, while an optical telescope requires a highly polished mirror with a figure quality measured in nanometers.

HST has also demonstrated the value of human servicing in space to repair, maintain, and upgrade such facilities. The next-generation space telescope, the James Webb Space Telescope (JWST), is being designed as a lightweight deployable 6.5-meter optical system but is not serviceable. It is possible to imagine even larger apertures in the future as the technology matures, growing to 10's of meters, and perhaps even to 100-meter sizes using distributed and thin-film apertures. Several of these large space telescopes, coherently coupled as an interferometer over baselines as long as 10,000 km, could accomplish extra-solar planet imaging. Many innovative ideas have emerged for such dilute-aperture telescopes, including arrays of telescopes optically coupled over large distances to create synthetic aperture sizes of 100 km size and larger.

The next generation space telescopes are being designed to overcome the thermal environment and orbital viewing constraints suffered by HST in low Earth orbit. SEL2 is an ideal location for cooled IR/submillimeter telescopes due to the absence of a warm body (Earth or Moon) nearby. Halo orbit at SEL2 is ideal for maximum viewing since the Sun and Earth subtend only very small angles and thus essentially the entire sky is continuously available for viewing. For an interferometer facility, several telescopes in orbits about SEL2 could achieve a large baseline and provide complete coverage of the observing plane for better images as they circle in halo orbits. The SEL2 observation point is close enough to Earth to enable essentially instantaneous communications, but far enough to avoid Earth-related duty cycle and thermal problems. At this short distance of only 1.5 million km from Earth, human servicing of a complex of co-orbiting instruments is a feasible concept.

Constellations of X-ray telescopes at SEL2 will be capable of micro-arcsecond resolution, detecting the earliest massive quasars in the universe and observing details in the event horizon of nearby Black Holes. Optical and infrared instruments will be observing the first events to occur as the early universe develops transparency and forms the first condensed matter objects. Far infrared telescopes will be observing the details of planetary system formation in the dusty interior of star-forming regions. And arrays of large optical/infrared telescopes will be mapping the surfaces of distant stars, imaging their planetary systems, and analyzing the light from their individual planets. These same telescopes will have unprecedented capability for high resolution imaging of even the most distant objects in our own solar system.

The only significant disadvantage of the SEL2 point for astronomical observations is its location in the inner solar system where zodiacal dust is the limiting factor to sensitivity. The only better place is the Sun-Jupiter L2 point beyond the zodiacal dust, but that is perhaps beyond feasibility in the next 50 years.

Objective 1.2: Observe and understand the process of planetary system formation in the galaxy.

We know that planetary system formation is relatively common in the Universe. We have detected Jupiter-like planets in close orbits around some stars, we have observed disks of gas and dust around newly-borne stars out of which planets may eventually form, we have observed the equivalent of Kuiper belts around more mature stars near the Sun, and we are developing a good theoretical foundation for the process of planet formation during the evolution young stellar disks. A thorough understanding of this process and its occurrence in star formation are critical to assessing the probabilities for planetary system



The Swan Nebula is a birthplace of young stars and planetary systems. Future observatories will provide the increased resolution and sensitivity necessary to fully understand the processes of star and planet formation.

formation and terrestrial planet formation in the Milky Way galaxy and the rest of the Universe. Constellations of telescopes at SEL2, operating in a variety of wavelengths, will enable us to probe star- and planet-forming regions in great detail and will allow us to observe them at all stages of evolution.

Objective 1.3: Survey the diversity and composition of small bodies in the solar system.

Comets, asteroids, and other small bodies are remnants of the original material from which the solar system formed, and so they represent exceedingly valuable storehouses of information on the origin of the solar system and life itself. Given their highly energetic orbits, comets and distant bodies such as the Kuiper objects will be explored exclusively by robotic missions for the foreseeable future. Such missions are of very high scientific priority, as evidenced by the number of missions targeting those types of bodies in current national space programs. The Near-Earth Objects, on the other hand, are not only scientifically important in their own right, but they are also well positioned to be of substantial benefit to a program of human exploration on the road to Mars.

Near-Earth Objects, also known as near-Earth asteroids, come in several families sorted by orbit type. They originated in the main asteroid belt and beyond the orbit of Uranus, then were perturbed by collisions and gravitational effects into their present locations in the inner solar



A number of asteroidal bodies have been visited by spacecraft. They range from the very low density (Mathilda) to rock (Eros and Gaspra).

system. They therefore represent easily accessible remnants from the time of planetary formation. From their composition we can learn about the conditions in the early solar nebula, the origin of the asteroids, the processing of small objects during the era of planetary formation and the role of asteroids in the planet formation process. From the distribution of their orbits we can learn about the processes that perturb them into the inner solar system and derive the statistics for their impact flux on Mercury, Venus, Earth and Mars. This information would be highly complementary to a study of the

impact flux on Earth from recent (within the last several hundred million years) cratering statistics on the Moon.

NEO's are relatively easy to reach because of the low energy requirement, lower than achieving lunar orbit in many cases, but require longer flight times. Questions of NEO diversity and composition can be addressed with a fleet of small robotic spacecraft to conduct remote studies during flybys of many NEO's, followed by robotic landers and possibly sample return from selected objects. Human exploration of NEO's, which would be primarily motivated by their

role as an intermediate destination on the path to Mars, would allow a much greater understanding of detailed NEO structure and composition, and would substantially expand our knowledge of these important members of our planetary vicinity.

Goal 2: Determine the origin and evolution of Earth and its biosphere.

There are four terrestrial planets in our solar system, but only one of them has developed advanced life. It is important to understand the uniqueness of Earth as well as the processes in the early stages of planet formation that enable the origin of life and ensure its survival as the planet evolves. While all evidence on the first billion years of Earth's history has been erased by tectonics, we may be able find such evidence on the Moon. The Moon ceased global tectonics early in its history and it is possible we might find remnant material from Earth's earliest history on the Moon. In addition, there is speculation that lunar mantle material may be exposed in certain deep impact basins, possibly providing insight into the original composition of the Earth prior to formation of the Moon. The activity of the early Sun had a major effect on the habitability of the early Earth, and we may be able to find clues to this history from solar wind particles imbedded in ancient lunar soil. Field work and laboratory research is already underway to examine the earliest samples that we do have on Earth for evidence on the early biosphere, its biochemical diversity and function, and whatever we can determine about the processes of life formation.

Objective 2.1: Search for evidence leading to an understanding of the origin of the Earth-Moon system.

The early U.S. Ranger, Lunar Orbiter, Surveyor and Apollo missions, Soviet Luna rover and sample return missions, and more recent Clementine and Lunar Prospector missions, all revealed much about what we know of the Moon today, but as in all science the results have created more finely tuned scientific questions and the need for further investigations. Among these is the need to complete an assessment of the global surface composition of the Moon. There remain some key elements and isotopes that have not been measured in spite of these previous missions. This information is necessary for fully understanding the Moon's thermal and volcanic history and for making an accurate assessment of the resource potential of the Moon. Much of this could be done with robotic orbiters and modern remote sensing instrumentation.

Our knowledge of lunar composition will always remain rudimentary without samples returned to Earth for analysis by precision instruments in Earth-based laboratories. *In situ* study of lunar samples can provide compositional information, especially if a practical age-dating instrument with some measure of fidelity can be



The Moon contains a 4.5 billion year old record of the origin of the Earth-Moon system. Apollo and other lunar missions have only scratched the surface of what the Moon can tell us about the history of the inner solar system.

developed for space flight, but Earth-based analysis will always be more comprehensive and precise. The determination of absolute ages of lunar minerals is a requirement for understanding the history of the Moon. These measurements now require analysis by ultra-sensitive, highly complex and massive instruments in Earth laboratories with extensive sample preparation by human laboratory technicians. While sample return can be done robotically, sample selection and characterization on the lunar surface is a critical function, and there remains a trade-off on the capabilities of lunar robots with human operators on Earth versus human lunar field geologists.

It will be necessary to determine the interior structure and composition of the Moon in greater detail than we know today. This can be accomplished with an *in situ* network of seismic stations and heat flow measurements on the surface. Emplacement of these instruments can be done robotically, although there is some controversy concerning the delicacy of the most sensitive of these instruments and the necessity for precise alignment that might argue for human emplacement. The collection of lunar polar ice cores, should such ice exist, and measurement of their composition with depth, could reveal much about the history of volatiles in the Earth-Moon system.

Objective 2.2: Search for samples from the earliest episodes in the history of the young Earth.



The discovery of meteorites from Mars on Earth established that large impacts on the terrestrial planets create high velocity fragments that escape the gravity field, fly through space and end up on the surface of another planet. There are meteorites from the Moon found on Earth, and there is every reason to suspect that the inverse is also true. Earth and the inner planets were subjected to heavy and massive bombardment in the first billion years of the solar system. There are scars from this early bombardment on the Moon. It is possible that tons of this material blasted from Earth in these early years rests now on the lunar surface, stones containing secrets to the first billion years of Earth's history just waiting to be picked up.

The Moon has a unique ability to record history. The lunar surface may harbor meteorites from the Earth's first billion years, transported to the Moon by large impacts. The lunar soil contains embedded solar wind particles; the ancient stratigraphic record exposed on the Moon may reveal a history of the luminosity and state of the Sun over time.

How did our planet begin its long evolutionary path to habitability? We have evidence from the earliest available rocks on Earth that life had already arisen more than 3.8 billion years ago at the end of the Hadean and the beginning of the

Archean age. Perhaps the clues we need to this early age are waiting to be identified and retrieved on the Moon. Samples of Earth ranging back into the late Hadean could tell us a lot about the early atmosphere, ocean, surface and climate when life was first evolving on the planet. If we knew the conditions on the young Earth that enabled the origin of life, then we could make a better assessment on the prospects for life originating on other planets as well.

John Armstrong has referred to the Moon as “Earth’s attic”. If so, then we should climb into that attic to find what valuable relics it holds that elucidate our planet’s ancient history. It is even possible that there may be samples of Venus mixed in with those early Earth samples. The challenge will be to identify samples of Earth or Venus in the lunar regolith. Studies will need to be conducted to determine how to identify such materials heavily diluted among lunar material and to derive the best strategy for finding them. The rewards of a successful search would be enormous.

Early Earth

The first billion years of Earth’s history has been erased from our planet’s geological record by continuing global tectonic processes, such as volcanism and plate motions, that modify and recycle surface material. Earth and other planets of the solar system are 4.55 billion years old, but the oldest rocks identified on Earth are rare and only 3.8 billion years old. We have no clues at all about what our planet was like in the first billion years of its history. This earliest age on Earth is called the Hadean, for surely the planet was very much like our vision of Hell, completely molten just after formation with a magma ocean surface and under constant massive bombardment by asteroids and comets ranging up to the size of small planets. The origin and evolution of the ocean, atmosphere, continents, crustal plates and early surface and climate are theoretical speculation without firm constraining evidence. Unlike Earth, the Moon ceased its tectonic activity very early in its history. Its surface material dates back to only a few hundred million years after the solar system formed. The Moon could be littered with debris from Earth’s Hadean age of bombardment, lying unchanged on the surface, or within a few centimeters of the surface, since it first arrived.

Objective 2.3: Obtain evidence on the Sun’s history and its effect on Earth through time.

The Sun propels enormous amounts of material into space in the form of hot tenuous plasma known as the solar wind. This wind is a sample of the composition of the surface of the Sun. As the Sun burns hydrogen in its interior over time, it produces new elements and isotopes that migrate to the surface and are expelled in the solar wind. This solar wind impacts the Moon and is trapped in regolith material, which is well preserved on the Moon. Age dating of lunar stratigraphy with atomic and isotopic analysis of the implanted solar wind in these layers can be used to determine the past history of solar luminosity as well as to predict its future evolution. This information will help us understand the past climate of Earth over the entire time that life has existed on our planet. Such collection and analysis may be accomplished robotically, but may require advanced *in situ* radiometric age dating. It remains to be determined whether human field geologists are required.

What will happen to us in the future?

Every human wonders about the future. One form of this question asks if there is any threat to us from space, especially after learning of extinction events by asteroid impact and after watching the Shoemaker-Levy-9 comet fragments impact Jupiter. We are using astronomical facilities to determine the population of Earth-crossing asteroids to define any threat, but we also need space missions to a number of such objects to examine their compositional diversity. These missions

are required to determine the bulk properties of NEO's in order to devise the means for any necessary mitigation. Another form of this question asks what future humans may have in traveling to and living on other planets. Is our species destined to populate space? We derive two key scientific goals to address these questions.

Goal 3: Determine the nature of the space environment and any cosmic hazards to Earth.

The Sun can enable life and can threaten it. It provides the energy that sustains life on Earth and the environmental conditions under which it exists, but ancient tree-ring and other records prove that the Sun's activity is not as constant as it seems on a daily or even annual basis. We can gain predictive ability about the Sun's activity by examining its history through direct observation, through preserved ancient solar wind records and by proxy through observations of other stars. This will provide the necessary understanding of the Sun's role in the origin and evolution of Earth's biosphere, and what we can expect from the Sun in the future. Also important to our past and future are the small body impactors that have rained upon Earth, in cataclysmic proportion during the formation of Earth and episodically thereafter. The history of asteroid and comet impacts will tell us the role these impacts played in forming the planet, in supplying its veneer of water and other volatile and organic material, and in the subsequent evolution of the surface of the planet including extinction events in the biosphere. The inert surface of the Moon can be used as a proxy record of the impacts erased on the more active Earth. The nature and distribution of small bodies in the solar system should be determined, including their bulk properties so that a strategy can be developed to deal with any NEO discovered in the future to be on an impact trajectory to Earth.

Objective 3.1: Determine the history of asteroid and comet impacts on Earth.

The Moon has recorded the history of impact bombardment since its solidification shortly after the formation of the solar system. It is a "witness plate" that can provide the statistics on impacts that must have occurred on Earth but whose evidence has been erased by Earth's turbulent tectonic activity. This lunar impact record extends to time periods earlier than the origin of life on Earth so that the chaotic disruptions caused by impacts on Earth can be used to understand the life forming process on early Earth.

In addition to assessing the effects of bombardment on Earth's environment in the Hadean, the post-mare cratering record on the Moon can yield information on other critical phases of the evolution of life on Earth. There is evidence that Earth is periodically showered with impacts, and these have been linked to mass extinctions. This hypothesis cannot be tested on Earth, but can be tested on the Moon by a careful examination of its cratering record.

Finally, the Moon preserves a record of the most recent impact history of the Earth-Moon system. There has been an increased awareness of the potential for future large impacts by Earth-approaching asteroids and comets. The time scale for such impacts is a strong function of size, and current statistics are not as accurate as the potential threat dictates they should be. There is a growing program for the identification, orbit determination, and monitoring of Earth-approaching objects in order to provide advance warning of any threat to the planet, but more accurate statistics are required to complement the observational techniques. These statistics could be determined by deciphering the late cratering history of the Moon from samples of a

large number of small (diameter 500 meters or less) post-mare craters. This could be done robotically combined with in situ K-Ar dating if it could be developed, or the samples could be returned to Earth robotically. A study is required to determine whether robots, assisted by Earth-bound geologist operators, can accomplish proper sample selection and make the required in situ measurements, or whether human lunar field geologists will be required.

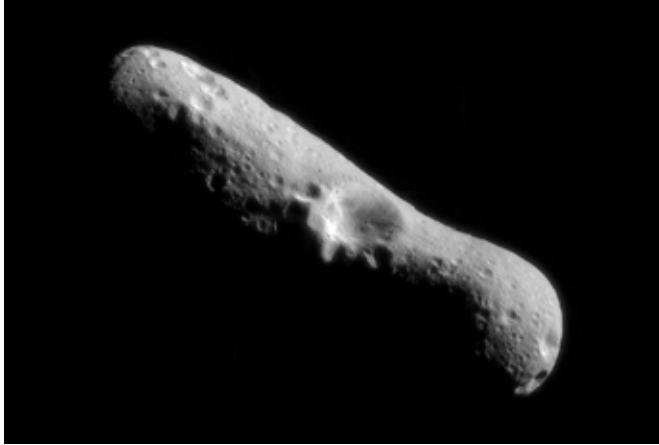

Eros, target of the Near-Earth Asteroid Rendezvous (NEAR) mission. Our understanding of the nature of NEO's has dramatically advanced in the past decade, but much more specific knowledge of structural characteristics and diversity is required if we are to devise impact mitigation strategies.

Objective 3.2: Determine the bulk properties and internal structures of NEOs.

If it should ever be necessary to destroy or divert an Earth-approaching NEO, it will be essential to know its bulk density and internal structure. These data are required in order to determine the best Earth impact mitigation strategy: orbit change, break-up, or pulverizing. It may be possible to infer with some measure of precision the bulk density and structure from diversity statistics given a spectral type and other remote measurements. If it turns out that these measurements are insufficient, then an *in situ* examination of the threatening object will be necessary. It is debatable whether this could be done with sufficient fidelity by exclusively robotic methods, and any mitigation devices may need to be placed and oriented very precisely. A trade study should be conducted on robotic vs. human approaches

to such mitigation studies, and the conclusions should be validated by the robotic diversity survey and *in situ* investigations.

Goal 4: Determine the potential for establishing human permanent presence in space.

Importing materials from Earth to space is very expensive, so a key to establishing a permanent human presence in the solar system is to find means to utilize resources found in space. This can be accomplished by examining the most accessible bodies in the solar system—the Moon, NEOs and Mars—for the potential to develop *in situ* resources including the production of energy, fuel and construction materials. Means to overcome local hazards, such as radiation, need to be developed and each destination should be exploited fully to support robotic and human utilization of space, planetary settlement, and potential commercial export to Earth. In the case of the Moon, the form, amount and origin of lunar ice should be determined in order to assess its potential as a resource for establishing permanent presence. NEOs have significant potential to supply material resources in space because of their accessibility and diverse composition.

Establishment of a permanent human presence on Mars, because of its distance from Earth, will almost surely require full exploitation of *in situ* resources. Current laboratory investigations of

the feasibility of *in situ* resource production on Mars should be accelerated and moved to the stage of pilot production plants on the planet itself.

Objective 4.1: Determine the utility of resource production on the Moon including potential lunar ice.

The Moon's regolith contains resources that might be useful for processing into materials and consumables for supporting human explorers on the Moon, for sustaining exploration of space beyond the Moon, or perhaps even for export to Earth. These prospects have been buoyed recently by the discovery that there may be water ice in permanently shadowed regions at the lunar poles. The distribution, form, and amount of any such ice in the polar regolith must be understood before the potential for supporting human exploration can be fully evaluated. This assessment can be accomplished robotically from lunar orbit with imagery to examine the extent of permanent shadow, infrared measurements for diagnostics of surface properties including detection of ice, remote temperature measurements to determine thermal conditions at the surface, radar to map the distribution of any ice deposits, and altimetry to map the topography in the vicinity. Robotic investigations should then follow to make *in situ* measurements on the surface and at depth to characterize these potential deposits in more precise detail.

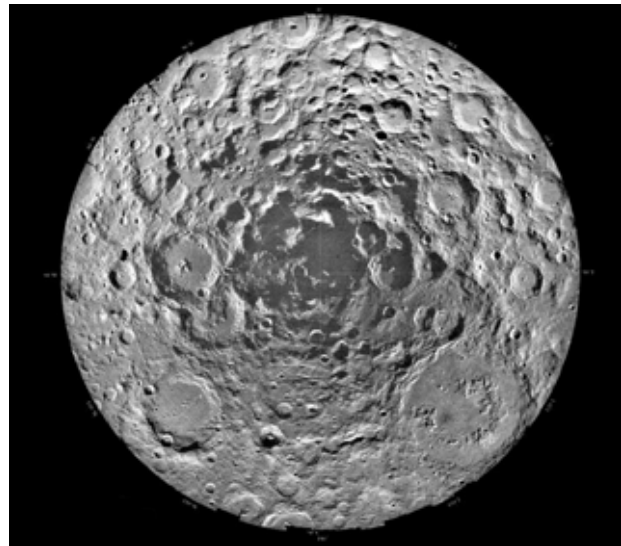

The South Pole of the Moon as imaged by Clementine, showing permanently shadowed regions where evidence of ice was found by Lunar Prospector. If confirmed, this would represent a significant resource that could have a dramatic effect on human expansion into the solar system.

In addition to assessing the value of these deposits for oxygen and fuel production for human exploration, these polar ice deposits have scientific value in their potential for unraveling the history of volatiles in the inner solar system as imported by comets. Water was one of the most abundant molecules in the early solar nebula. It was a key molecule involved in the condensation of minerals in the hot nebula, the formation of the giant planets, and the origin and development of oceans and atmospheres on the terrestrial planets. Comets were a major repository of water in the early history of the solar system and may have been responsible for the import of a large fraction of Earth's inventory of surface water.

Objective 4.2: Determine the utility of NEOs as potential resources for materials in space.

NEOs may be accessible repositories of resources for supplying in-space needs for deep space exploration or for export to Earth. A robotic diversity survey and *in situ* missions will provide preliminary data necessary to assess the utility of NEOs for this purpose. If results are promising, then more in-depth exploration of representative NEOs will be necessary, including

return of selected samples from multiple sites on NEOs and including drill cores as well.

It is possible that robotic missions would be sufficient to determine the viability of resource production on NEO's, but human presence may be required to fully establish the capability. A trade study should be made of the specific requirements and the ability of future robotic missions to accomplish them. Even should NEO mining ultimately turn out to be a viable proposition for either space exploration purposes or for export to Earth, it is not entirely clear that human NEO miners and exporters will be necessary.

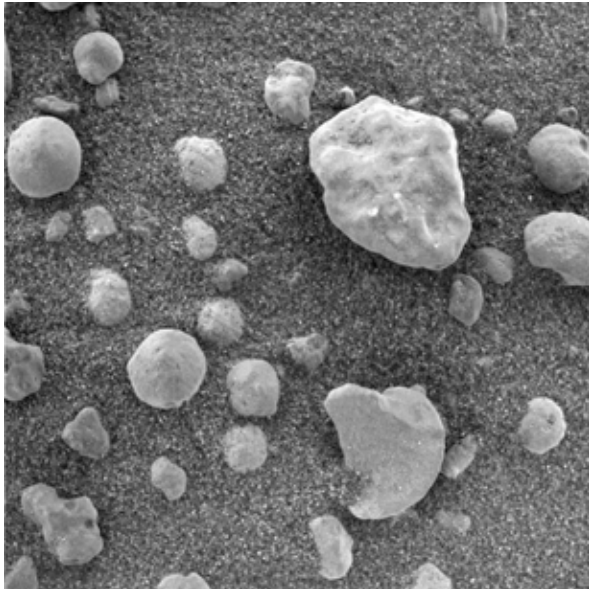

We now have the capability to examine in great detail the surface characteristics and chemistry of Martian rocks and soil. This is a key step toward understanding the potential for in situ resource utilization at Mars. This is a microscopic image from the Mars Exploration Rover.

Objective 4.3: Determine the feasibility of in situ resource production on Mars.

Mars will be a major focus for solar system exploration in the next 50 years, so development of methods to produce resources *in situ* on Mars has the potential to significantly reduce long-term exploration costs. There have been studies and laboratory experiments that show the possibility of producing rocket propellant from the atmosphere. Evidence is accumulating that large quantities of water ice may be accessible just below the surface over large parts of Mars, so it is possible that this ice can be mined for the liquid water crucial to establishing a permanent human presence on the planet. Water can also be processed into oxygen for breathing and into both hydrogen and oxygen for rocket propellant. The energy for water mining and processing may require a nuclear power plant or perhaps a large solar collector. Small robotic pilot projects can be conducted on Mars to determine the feasibility and economics of *in situ* resource production. The local production of construction materials, fuel, water, power and other consumables will be

key to establishing robotic outposts, and from these outposts ultimately a human presence on Mars.

Are we alone in the Universe?

By learning how life may have started on Earth we can determine what possibilities there may be for an independent origin elsewhere in the solar system and the Universe. But contemplating the possibility is not enough; as human beings we are compelled to find its answer. Most scientists see the possibilities and are overwhelmed by the notion that the universe might be teeming with life. Space science has adopted the goal of searching for life in the most promising places in the solar system, and looking for Earth-like planets outside the solar system. We derive two key scientific goals to address this question, first to determine if there is or ever has been extra-

terrestrial life in the solar system, and second to determine if there are planets with life around other stars. Since our focus is on space-based investigations, we do not include ground-based activities such as SETI (Search for extra-terrestrial intelligence).

Goal 5: Determine if there is or ever has been extra-terrestrial life in the solar system.

After more than 40 years of robotic planetary exploration, the best solar system bodies on which to look for evidence of past or present life, particularly in primitive biogenic forms, are known. These are the surface and immediate subsurface of Mars, the deep subsurface oceans of Jupiter's large icy satellites Europa, Ganymede, and Callisto, and Saturn's moon Titan. Titan's surface and atmosphere may also hold clues to the earliest chemistry on Earth that enabled the origin of biology on our planet. Mars is the most accessible of these locations, particularly for human exploration in the next 50 years. The geological and climatological histories of Mars are crucial to assessing the potential for an independent origin and evolution of a biosphere on Mars and to learning about Earth's own history by comparison. The key to actually finding evidence of past or present life on Mars is to use this history to follow the water. Knowledge of the form and distribution of water on the planet, in the past up to the present, will tell us precisely where to look.

Objective 5.1: Determine the geological and climatological histories of Mars.

Mars is the planet in the solar system whose surface environment is most like Earth. Venus is closer in distance, size and mass, but its surface environment is very different and extremely hostile to life. The Martian surface environment is also hostile, but benign in comparison to hellish Venus, and there is evidence that Mars had a more habitable climate in its past and has undergone climatological cycles, linked to orbital and obliquity changes, that episodically may have produced a warmer and wetter surface environment. There is every reason to believe that 4 billion years ago the surface environments of the two young planets, Earth and Mars, were very similar when life first arose on Earth. So by extension, there is a fair possibility that life may have arisen on Mars at that time. If there was life on the young Mars, there may be fossil indications of that life to be found, or life may have survived and still exist today, hidden below the surface of Mars where liquid water and sources of chemical energy may yet be found.

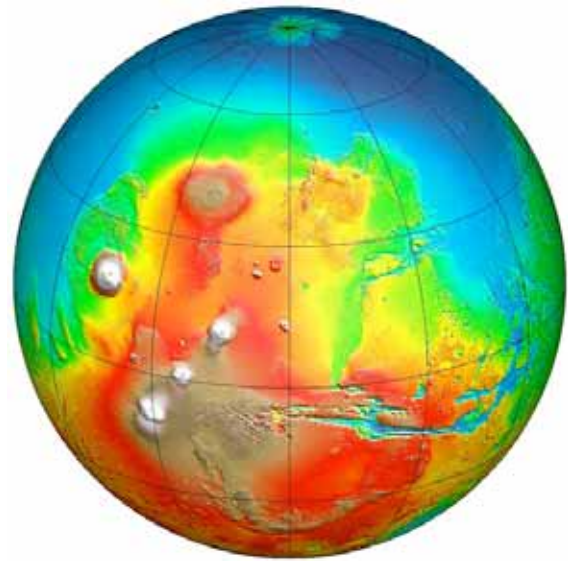

On this topographical map of Mars, blue indicates low elevations and red to white indicates high elevations. We will learn about the evolution of geological features and climate change on terrestrial planets by comparing what we know of Earth with what we will learn from exploration of Mars.

By exploring the geological and climatological history of Mars, we are examining the evolution of another Earth-like planet. The knowledge to be gained will help us to understand how terrestrial planets are built and evolve, how a habitable environment can be established and

maintained, how that environment can evolve to become biological, and what the prospects may be for other habitable planets in planetary systems around other stars.

Mars, like Earth, has hemispherical asymmetry. Earth has an asymmetry between its large continental masses and ocean basins, and a related north-south asymmetry with most continental mass in the northern hemisphere. Mars also has north-south asymmetry with a large, low and relatively flat northern basin and an elevated cratered southern highland. This large northern basin may be the remnant of an early ocean on Mars. At some point in the history of Mars all of this surface water, for which we see so much evidence on the planet, completely disappeared and the planet's atmosphere became thin and dry, no longer capable of supporting liquid water on the surface. This may be a cyclic phenomenon or a permanent global change, but we do not know the causes or mechanisms. We need to explore Mars to understand this global planetary change from a thicker atmosphere with a warm and wet environment, to a thinner atmosphere with a cold and dry environment. We need to learn from Mars how this process can occur on any terrestrial planet and change its surface from habitable to hostile.

Global Change on Mars

The geological history of any planet is intimately intertwined with its surface environment and climate. The mass of the planet, its orbit around the Sun, and planetary tectonic and exogenic processes determine the extent and composition of the atmosphere, surface temperature, and stability of volatiles such as water. All of these climatologic properties change as the planet evolves. Our own planet has undergone massive global environmental change induced by biology (the development of an oxygen-rich atmosphere), tectonic activity (major volatile input and climate change) and impact events (mass extinctions and climate change).

Mars has also undergone global change during its history. The terracing of its northern polar areas is evidence that Mars, like Earth, has experienced ice ages (like the one it is in now) alternating with warmer and presumably wetter ages. Mars also shows evidence of cataclysmic events in which massive volumes of water have flooded its surface, creating large drainage channels and basins. There are surface manifestations today of potential subsurface liquid aquifers in the present dry age on Mars.

Objective 5.2: Determine the history of water and its present distribution and form on Mars.

The key to exploring Mars is to “follow the water”. Scientific results from robotic missions show that the history of Martian water and the distribution of its repositories are strongly coupled to the geological and climatological histories of the planet. Water is the thread that runs through

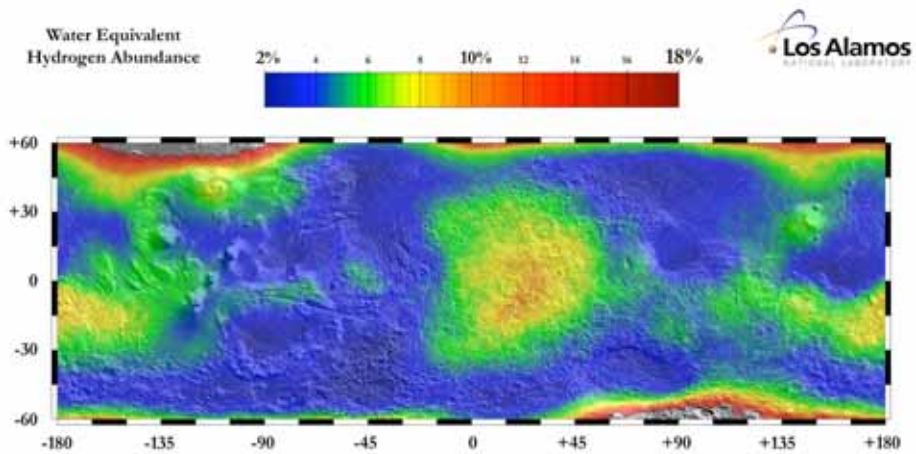

Map of near-surface ice from the Mars Odyssey mission. To understand the potential for past or present life and the future habitability of Mars, we must determine the history of water and its form, amount, and distribution on the planet.

all aspects of the surface environment the planet. Water has been a major erosional force on the planet in the past; its features are written all over Mars. Water has been a major climatological force during the history of the planet. There is enough water locked up in the seasonal polar caps today to cover the surface of Mars to a depth of 20-30 meters. Water is a major element in present day Martian weather. While present in only trace amounts, the atmosphere is quite often fully saturated with water. There are hidden reservoirs of ice and perhaps water in the subsurface, evidenced by seepage channels in cliffs and crater walls and the strong near-surface signals of ice seen by the Mars Odyssey spacecraft. The layered polar deposits probably contain as much as 20-50% water ice.

Liquid water in extensive aquifers could exist 2 km below the surface, and there is evidence of catastrophic outbreaks of such aquifers in the past. Global remote sensing and sounding should be conducted to identify potential sites where there might be subsurface ice or water, and then *in situ* exploration should be conducted at these sites with additional sounding and with drilling to find and exploit this resource for establishing a human outpost on the planet.

Objective 5.3: Search for past and current life on Mars and in the subsurface ocean of Europa.



Europa, Mars, and Titan. Strong evidence of liquid water on Europa and Mars make us hopeful that we may find clues to a possible independent origin of life in the solar system. Titan is less likely to ever have developed life, but may reveal the processes that lead to production of the chemical stuff of life.

One of the most compelling questions humans can ask is “*Are we alone?*” On Earth, wherever there is liquid water there is life, and the same may be true of Mars. Mars may have developed an independent origin of life early in its history when it was warmer and wetter, and that life might have survived at depth where water may have remained liquid. Mars is therefore a most compelling place to answer the question ‘did life ever arise elsewhere in the solar system?’

The search for current life on Mars is the search for liquid water. Life requires both a source of liquid water (only a dab will do) and a source of chemical energy. Life is not particular about what it “eats” and seems able to adapt to whatever chemical energy source is available. Life on Earth can exist on hydrogen, carbon dioxide, hydrogen sulfide, iron, manganese and host of other energy sources, so that Martian life could do the same on mineral deposits and on gases escaping from the interior. But liquid water is an absolute requirement. The search for extant life should therefore focus on areas where surface mineralogy and subsurface sounding indicates a concentration of ice and perhaps water at accessible depths below the surface. Sites where volatiles are escaping, particularly with some reduced components such as H₂, would be

particularly exciting.

Likewise, the search for past Martian life is the search for locations of past liquid water on the planet. Tectonic activity on the planet will likely have left samples on the surface with some fossil evidence of past biological processes. This fossil evidence could be in the form of characteristic elemental distributions, isotope ratios, organic residue and perhaps even microfossil morphologies in carefully selected rock samples. Finding such evidence can be accomplished with an orderly procedure starting with a search from orbit for a set of promising sites, followed by an in situ examination of the identified sites to certify which is most suitable, and finally concluding with in-depth study at one more particularly promising sites to include very detailed local examination, drill samples and perhaps sample return to Earth depending on in situ measurement capability at that time.

The search for evidence of past or extant life on Mars should initially be done robotically and an assessment made after these initial efforts on the extent to which humans may be required in order to be satisfied that this search has been carried out to the maximum extent possible. If evidence were to be discovered during the robotic phase, this would no doubt create a major imperative for human explorers to research the history of life on Mars in situ. And the exploration of Mars by humans would have to take into account potential backward and forward planetary contamination and biological hazards to the astronauts.

Beyond Mars lies Jupiter with its large Galilean moons. There seems little doubt that Callisto, Ganymede and Europa harbor subsurface oceans following the evidence gathered by the Galileo spacecraft, but their fluidity, depth, and extent are unknown. The most intriguing is ice-covered Europa with surface manifestations of a more mobile fluid underneath. If there is an ocean beneath this ice, then it is sustained by heat flow from the interior of Europa, quite likely by tectonic processes that might also bring mineralogical nutrients into the ocean. On Earth, this is a recipe for life. Robotic spacecraft will pursue this prospect in the next decades. If any evidence for the possibility of life is uncovered in the oceans of the Galilean moons, they may become a target for human explorers sometime in the second half of this century.

Goal 6: Determine if there are life-bearing planets around other stars.

It has only recently become possible to indirectly detect massive gas giant planets around other stars. These detections have encouraged the development of technically more difficult space optical systems, such as NASA's SIM and TPF missions and ESA's GAIA astrometric and DARWIN interferometric missions, to directly detect the light from smaller and even terrestrial-like planets. Still larger aperture systems than these will be required to examine the spectrum of extra-solar planetary light to search for evidence of life on these planets. Ultimately, super large space optical systems can be envisioned capable of imaging extra-solar planets. These large and complex systems are best located at the SEL2.

The approach to meeting this goal can therefore be condensed into two main objectives, first to search for terrestrial-like planets around other stars, and second to search for evidence of life in the observational properties of extra-solar planets.

Objective 6.1: Search for terrestrial planets around other stars.

The search for terrestrial planets around other stars will begin with smaller space telescopes using planetary transit photometry techniques--missions such as COROT, Kepler and Eddington. Given proper orbital plane alignment with the solar system, these missions will be able to directly detect the presence of terrestrial-size planets about other stars, and can determine their size and orbital position about the star, but nothing of their surface and atmospheric properties. To learn about the surface and atmosphere of extra-solar planets, advanced interferometric and coronagraphic techniques will be required, such as embodied in the TPF and DARWIN concepts, to isolate the light of the planet from its host star. Sufficient aperture will be required to isolate enough light from the planet for dispersal into a spectrum for analysis of atmospheric and surface features.

Objective 6.2: Search for evidence of life in the observational properties of extra-solar planets.

The technology can be envisioned today for isolating the light from planets circling other stars and to examine the spectrum of this light for atmospheric properties including composition and



to some extent even surface properties of the planet. The habitability of the planet can be deduced from this information. NASA and ESA have plans for space interferometers to isolate and detect the light from terrestrial sized planets around the nearest stars. These early systems will be capable of determining the existence and statistics for terrestrial planets in the solar neighborhood, but larger apertures will ultimately be required to collect sufficient light from distant terrestrial sized planets for dispersion into a spectrum of sufficient intensity and resolution to determine atmospheric and surface properties. Tomographic techniques using rotational modulation of the light flux and spectra could give constraints on the distribution of continental features. Large aperture systems at SEL2 will be required. After having achieved the ability to detect and study the light from these planets, the next step will be actual imaging.

Today's technology enables us to detect large Jupiter-like planets around other stars. Over time, we will develop the capability to image such planets (as shown in this artist's concept) and eventually to detect and image Earth-like planets. Such revolutionary achievements can be enabled by the development of SEL2-based constellations of telescopes.

There will come a time in the first half of the 21st Century when humankind will be treated to the first image of an Earth-like planet around another star. That image will have an even larger effect on the human consciousness than did the first global image of Earth taken from space by Apollo 8 in 1968. We know now what technologies can be applied to obtain that image—space interferometers and coronagraphs—but we have difficulty imagining the scope of its application to achieve the goal. It is the same as looking into the future at the beginning of the 20th

Century believing that the airplane will be used some day to carry human passengers across the country, but with no idea how to imagine a Boeing 747 or Airbus.

Imaging of an extra-solar planet, circling a star 50-100 light years away, with sufficient resolution to discern continents from oceans and clouds from ice caps, is an almost unimaginable prospect. Yet it does seem possible with extrapolation of current astronomical technology. A telescope with a synthetic aperture of hundreds of kilometers is required with large light gathering capacity. Today we can imagine a space interferometer design consisting of two or more 20-30 meter apertures separated by thousands of kilometers in space and coherently coupled with a combination of precision spacecraft station keeping and laser metrics for the optics.

Destinations for Human Space Exploration

These goals and objectives provide the context for human exploration beyond Earth orbit, and their fulfillment will require a program of scientific investigation at specific destinations. The scientific imperative in and of itself is not sufficient—it must be coupled with the exploration and political imperatives to form a sustainable program—but scientific investigations that make use of unique human capabilities will be primary factors in the determination of where humans should go and what they should be prepared to do there. There is no single destination for human exploration, as was the case during the Apollo era; today there is a set of destinations that is scientifically and culturally compelling, with Mars as the ultimate objective for human exploration in the next 50 years.

From our examination of the scientific, cultural, and political imperatives, four key destinations emerge as the most important: Sun-Earth L2, the Moon, Near-Earth Objects, and finally Mars. These all share three important characteristics:

- 1.) Each destination will play a role in answering the fundamental human questions that we are now poised to address, and realistic and achievable investigations can be defined that will meet the science objectives.
- 2.) Each of these destinations is amenable to human exploration in the next 50 years, with reasonable investments in foreseeable technologies.
- 3.) Each destination represents an important stepping-stone toward the following destination and ultimately to Mars, and establishes an important component of a permanent human presence in the solar system.

The table below traces the scientific imperative from fundamental questions all the way through to the identification of specific destinations for human exploration.

<i>Translate compelling questions...</i>	<i>to science goals...</i>	<i>to exploration objectives...</i>	<i>at specific destinations.</i>
Where did we come from?	Determine how the universe of galaxies, stars and planets began and evolved.	Survey matter in the universe across the spectrum and to the beginning of time.	with telescopes at Sun-Earth Libration Point L2
		Observe and understand the process of planetary system formation in the galaxy.	with telescopes at SEL2
		Survey the diversity and composition of small bodies in the solar system.	on Near-Earth Objects
	Determine the origin and evolution of our own Earth and its biosphere.	Search for evidence leading to understanding the origin of the Earth-Moon system.	in the regolith and rocks of the Moon
		Search for samples from the earliest episodes in the history of the Earth.	in Earth meteorites found on the Moon
		Obtain evidence on the Sun's history and its effect on Earth through time.	in the regolith and rocks of the Moon
What will happen to us in the future?	Determine the nature of the space environment and any cosmic hazards to Earth.	Determine the history of asteroid and comet impacts on Earth.	in the local cratering record on the Moon
		Determine the bulk properties and internal structures of NEOs.	at and on Near-Earth Objects
	Determine the potential for establishing permanent human presence in space.	Determine the utility of resource production on the Moon including lunar ice.	on the Moon
		Determine the utility of NEOs as potential resources for materials in space.	on Near-Earth Objects
		Determine the feasibility of <i>in situ</i> resource production on Mars.	on Mars
Are we alone in the universe?	Determine if there is or ever has been extra-terrestrial life in the solar system.	Determine the geological and climatological histories of Mars.	on Mars
		Determine the history of water and its present distribution and form on Mars.	on Mars
		Search for past and current life.	on Mars and Europa
	Determine if there are Earth-like planets with evidence for life around other stars.	Search for terrestrial-like planets around other stars.	with telescopes at SEL2
		Search for evidence of life in the observational properties of extra-solar planets.	with telescopes at SEL2

Robotic missions at each destination will continue to play an important role in a comprehensive human exploration program. From the outset of the space program, human activities have been preceded by and enabled by robotic missions; as we move out into the solar system, permanent human presence will likewise be preceded by intensive robotic exploration at each destination. These robotic precursors will help to establish specific scientific objectives for human explorers and will lay the groundwork for safe and effective human exploration. Expandable and intelligent robotic outposts, designed from the outset to ultimately support human explorers, will be critical to enabling safe and effective human exploration of Mars.

Sun-Earth L2

In 1772, the French mathematician Joseph L. Lagrange showed that there are five positions of gravitational equilibrium in a rotating two-body gravity field. Three of these Lagrange points—also called “libration points”—are situated on a line joining the two attracting bodies, and the other two form equilateral triangles with these bodies. As shown in the figure below, a total of seven libration points are located in Earth’s neighborhood, five of which derive from the Earth-Moon gravitational system and two which derive from the Sun-Earth system. Although the collinear points are unstable, very little propulsion is needed to keep a spacecraft at or near one of these points for an extended period of time. This unique gravitational balance and consistent geometry makes the libration points very important locations in a long-term human space exploration architecture. In particular, the Sun-Earth L2 point is the ideal location for large constellations of telescopes dedicated to detecting Earth-like planets and life in the cosmos, and it is an excellent stepping-stone to more distant destinations.

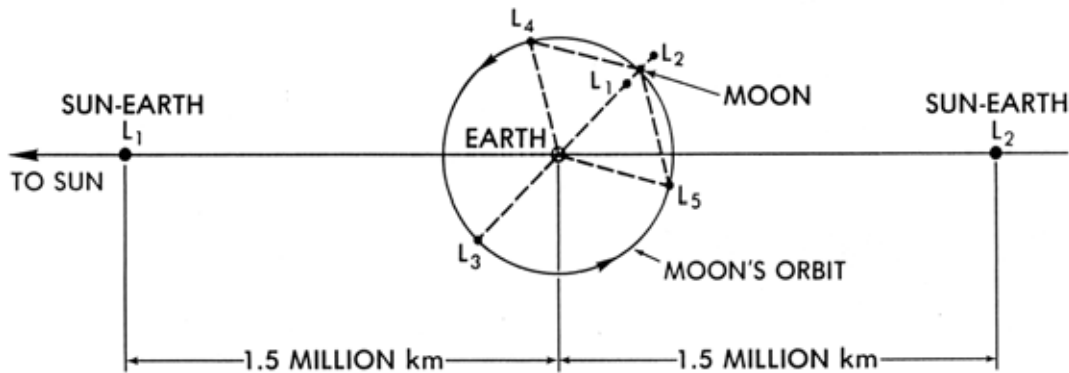

Libration points in the vicinity of Earth.

Beginning in 2007, orbits in the vicinity of Sun-Earth L2 (SEL2) will be the locations of choice for a number of large astronomical facilities. This provides several important advantages: Viewing constraints are minimized because the Sun, Earth, and Moon all lie in the same direction providing a space telescope with an unobstructed view of almost the entire sky at all times; the environment is essentially zero-g and thermally benign; and Earth eclipses can be avoided, ensuring a continuous source of solar power and uninterrupted observations. NASA’s James Webb Space Telescope (JWST), the successor to the Hubble Space Telescope, is presently planned for an SEL2 operational orbit. Two future NASA observatories, Constellation-X and the Terrestrial Planet Finder, as well as the ESA observatories Herschel, Planck, and Darwin are also expected to operate in SEL2 halo orbits.

In the more distant future, building on these projects and their expected discoveries, SEL2 will become the preferred location for the most fantastic space observatories ever conceived. Large constellations of telescopes will enable us to find, study, and ultimately image Earth-like planets around other stars and to probe the mysteries of the deepest universe. An important aspect of these investigations will be the need for human servicing and possibly on-site construction of these large systems. As we have seen in Earth orbit, there is no substitute for the capabilities of the human mind and body when it comes to assembling, trouble-shooting, and repairing complex

spacecraft. While the early astronomy missions to SEL2 have not been designed for human servicing and repair, this situation will surely change as the telescopes become more complex and expensive. Thus the construction and maintenance of large astronomical facilities at SEL2 may provide a compelling rationale for the initial step in a program of human exploration beyond low Earth orbit. The capabilities developed to enable construction and servicing of these large facilities will be an important step toward the overall set of capabilities required to provide human access to the Moon, near-Earth asteroids, Mars, and beyond.

The table below lists some of the possible investigations and the human-assembled or serviced telescope systems they will require.

Investigation	Candidate System
X-ray studies of high-energy objects (quasars, black holes)	Interferometric constellation of 10-meter class grazing-incidence telescopes
Optical and infrared studies of the deep universe and extra-solar planetary systems	20-meter class cooled aperture telescope, expandable to 100-meter class with upgrades including a coronagraph
Optical and infrared imaging of extra-solar planets	Multiple 20-meter class cooled apertures, expandable to 100-meters, coherently linked optically over a baseline of 1000 -10000 kilometers
Far infrared and sub-millimeter imaging of proto-stellar gas, dust, disks, and young planetary systems	Dual 30 meter or larger cooled (~10K or less) apertures over a 10 km interferometric baseline, with narrow-band Terahertz receivers (500-1500 Ghz)

SEL2 also represents a relatively benign and low-risk destination for human space flight development and staging. Its unique location at the edge of Earth’s gravitational influence makes it an energy-efficient starting point for missions to deep space. Having developed the capability to travel to SEL2 for telescope construction and servicing, astronauts at SEL2 may also help to develop and test systems that will be used for journeys to more distant destinations. Preparing, servicing, and fueling interplanetary vehicles at SEL2 prior to their departure for NEO’s or Mars will allow us to minimize the program’s dependence on expensive new propulsion technologies and will help to reduce the total flight time an interplanetary crew must spend



The value of human space flight as an enabler of science was amply demonstrated by astronaut deployment and maintenance of the Hubble Space Telescope.

in deep space. The capabilities developed to enable astronauts to live and work at SEL2 will be an important programmatic step toward these more distant destinations.

The Moon

The Moon is a readily accessible small planet, and we can learn from its composition and interior structure much about planetary construction and how the Earth-Moon system formed. The Moon is in some ways a Rosetta stone, providing a template for deciphering and understanding the history and evolutionary processes of the terrestrial planets. Due to its lack of atmospheric weathering and geological activity, the surface of the Moon may be a repository of information from the earliest epochs of the inner solar system. Impact-generated samples of the early Earth, Mars, and asteroids may lie on the surface, and it has been postulated that samples of lunar mantle material may also be exposed as a result of large impacts. This may represent our best hope of directly sampling the material from which the Earth-Moon system formed. We may also be able to learn about the impact flux of asteroids and comets on Earth over time using the cratering record preserved on the Moon, and solar wind ions trapped and buried in the lunar surface may elucidate the history of the Sun. One important activity for human explorers will be to search the lunar surface for such scientifically unique and valuable samples.

The Moon has frequently been proposed as a platform for astronomical telescopes. The most compelling of these is a far-side low-frequency radio telescope where interference from the overwhelming background of commercial radio broadcast traffic is eliminated. There are significant challenges to emplacing large telescopes on the Moon including mitigation of lunar dust, the local atmosphere near a human-occupied base, large thermal excursions between lunar day and night, and the large propulsion requirement for the repeated trips into and out of the lunar gravity well that will be needed for construction and servicing.

Comet impacts over the eons may have resulted in an accumulation of water ice in permanently shaded regions at the poles. Some studies have suggested that there may be as much as 10 billion tons of water in the polar regions, potentially a valuable source of oxygen and rocket propellant for future human explorers. Utilization of these resources to enable missions deeper into the solar system is one of the compelling reasons for intensive human activity at the Moon in the context of a long-term exploration program. If such resources prove to be present and accessible, they could be processed on the Moon and transported to a point in space, such as high Earth orbit or a libration point; such a location would be more suitable as a departure point for interplanetary trajectories than would the lunar surface. Finally, the Moon may represent a potential resource for commercial exploitation. There have been many proposals to export lunar resources for use on Earth, as well as proposals to use lunar-generated energy and to use the Moon for education, entertainment, or space tourism. In this study we have focused strictly on the scientific and exploration potential of the Moon and have left assessment of resource exploitation and commercialization to other studies.

In addition to its intrinsic science value and its potential importance as an observational platform and a resource node, the Moon provides several additional benefits to a stepping-stone approach into the solar system:

An exploration proving ground. The Moon is a natural space station, providing a benign environment with one-sixth gravity for human utilization and exploration. There is some evidence that the adverse effects of weightlessness on the human body may be absent or substantially reduced in lunar gravity. The proximity of the Moon suggests its potential as a training ground for human exploration of Mars. However, this potential needs to be assessed against the vast differences in thermal, gravity, dust, atmospheric and other environmental factors between the Moon and Mars. It may be more efficient to train for Mars using high-fidelity simulation facilities set up on Earth.



Apollo 17 astronaut Eugene Cernan drilling a core sample on the Moon.

Off-world habitat development. A lunar outpost might be useful for testing approaches to constructing a planetary habitat utilizing in situ resources and minimizing those imported from Earth, thus setting the stage for habitats on Mars and other Solar System objects. The main elements needed for life support—oxygen, hydrogen, nitrogen, and carbon—are available in the lunar regolith, albeit at extraordinarily low concentrations except for oxygen, which is tightly bound chemically within the minerals. It will require considerable energy to refine lunar rock for these elements. Bulk construction materials are also available in the form of iron and aluminum in regolith metals, ceramics and glasses from regolith silicate minerals, and sintered regolith as a lunar variety of cinder block. Except for the potential polar water deposits, most of the Moon's resources are understood well enough today, awaiting technology development and demonstration for processing and use.

Near-Earth Objects

The Near-Earth Objects (NEO's), also known as near-Earth asteroids, are nearby remnants of planetary formation. Their structure and composition may hold clues to important scientific questions of the history of the inner solar system. In addition, since they pose by far the most significant impact threat to Earth, an understanding of their diversity and their physical characteristics could someday be vital to averting a potential global disaster. These objects impact Earth regularly, with mean times between collisions dependent upon size; the larger objects fall much less often simply because there are fewer of them. There are recent and dramatic impact scars on Earth, including the 50,000-year old crater near Winslow Arizona, and the massive blow down scar of the 1908 Tunguska event (probably a comet impact) in Siberia.

The primary properties of composition and bulk density must be determined in order to understand NEO structure, the nature and severity of possible impact threats, and the efficacy of various mitigation strategies. Much of the required investigation can be done robotically, but it may ultimately be important to enable human explorers to use their powers of observation, intuition, and active testing to fully understand the detailed physical nature of NEO's and to validate impact mitigation techniques. Development of the capability for human operation on and near NEO's, in advance of the discovery of any specific impact threat, could turn out to be a wise investment.

NEO's also represent substantial mineral resources in space relatively near Earth. Because NEO's have very low gravity, transportation of these resources to other locations can be done relatively inexpensively, and thus they could be extremely useful in the development of a long-term human presence in space. Early human explorers at NEO's could complete resource assays begun by robotic missions, select the best locations for resource processing units, and initiate their operation. It may also be determined that NEO resources have commercial potential, in which case larger-scale processing operations requiring human presence may be appropriate.



Wolf Creek Crater, one of the few impact craters on Earth that have not yet succumbed to tectonic processes and weathering. Impacts have played a significant role in the history of life on Earth.

A number of technical and programmatic trade studies are required in order to assess the relative importance of human and robotic missions to meet the NEO science, resource utilization, and impact mitigation objectives. By far the strongest imperative for human missions to NEO's arises from consideration of their utility as an intermediate step to Mars. Their locations and physical characteristics will stretch the capabilities of human exploration just enough to greatly reduce the risk of the Mars missions to come. NEO's will thus play an important architectural role as a bridge between Earth's neighborhood and Mars.



A portion of Valles Marineris as seen by ESA's Mars Express mission.

Mars

Mars is the most Earth-like planet in the solar system and almost certainly had a warmer and wetter environment early in its history, with flowing and standing water on its surface. Mars may have developed life, and while its surface appears lifeless today, an early biosphere may have survived at depth where liquid water might still exist. Mars is the most accessible place in the solar system where we can search for evidence of an independent origin of life. From Mars we can learn about the origin and history of an Earth-like planet that has taken a different path in planetary evolution. By comparing the geological and climatological histories of Earth and Mars, we will gain clues to what it takes to construct a habitable planet and how that habitability may be sustained or lost over time. Another reason to explore Mars is to search for potential resources that might be useful for human occupation. All of these objectives share a common thread—water. When in the planet's history was there liquid water, where was it, in what form was it (rain, rivers, lakes, and oceans) and how much was there?

Interest in Mars exploration is universal. International cooperation continues to exist on the scientific and instrumental level. These national programs are coordinated in an informal manner through the International Mars Exploration Group. Hopefully through these missions, enough experience and interest will have been gained to formulate a more structured international approach in the following decade. This international program should provide for a continuous and comprehensive approach to exploring Mars robotically, including emplacement of common Mars communication and transportation infrastructures and the construction of robotic outposts on Mars to prepare for eventual human arrival.

A scientifically and technically productive first step in the Martian system may be for human explorers to orbit Mars or to land on Phobos or Deimos. From these vantage points, astronauts could operate robotic elements on the surface to explore and to prepare an outpost for future human landed missions. These tele-robots could be operated in real time, without the time delay imposed by Earth communications or the need for complex autonomy to circumvent it. This would provide a tremendous advance in exploration capability, and would allow the development of a sophisticated robotic outpost with an optimum physical configuration of assets with respect to one another and to Martian surface features. A mission to Mars orbit or to one of the moons would be very similar to a human NEO rendezvous and landing mission, making it a valuable and lower-risk incremental step in between an NEO mission and a human Mars surface mission. It is also possible that a human outpost could be set up on one of these moons for conducting Mars remote sensing and surface robotic operations.

Architecture

Based on the scientific objectives and destinations that have been derived, this architecture presents a systematic framework for human exploration leading ultimately to the capability for human exploration of Mars. It must be emphasized that it is the philosophy that is embedded in this architecture that is important at this stage, not the particulars of any specific implementation. Our goal is not to prescribe and defend a particular mission set, but rather to provide a framework within which options and trade studies can be identified and assessed. We will present one potential set of steps as an example of what may be done, but we recognize that there are a tremendous number of variables and that there is no way to predict now how the program will unfold.

Human Exploration: Imperatives and Requirements

Cost-effective human exploration of deep space is clearly a tremendously challenging problem with an enormous spectrum of technologies and implementation trades that must be considered. At the risk of over-simplifying, we can assert several top-level imperatives that must guide our decisions through this trade space. These imperatives can be used as a starting point for the definition of requirements that major exploration elements must satisfy.

Mission Imperative	Derived Requirement on Architecture
Crew health	Minimize flight time in deep space Provide life support and countermeasures
Crew safety	Utilize proven transportation technologies Pre-emplace assets and verify functionality prior to crew arrival
Mission success	Provide sophisticated instruments and robotic assistants Provide access to a variety of solar system destinations
Mission affordability	Systems should be of broad benefit at multiple destinations Leverage current investments and utilize proven systems
Responsible exploration	Protect possible life-bearing environments Safeguard against planetary contamination

Architectural Principles and Stepping Stones

We have identified a set of scientific objectives and destinations that provide a framework for a compelling program of human exploration of the solar system. In view of the many variables to be considered in the years to come, flexibility must be established as one of the hallmarks of this or any other exploration architecture. Individual destinations and related investments can be included or excluded as the program evolves, based on scientific discovery and technological progress, risk and cost, public interest, international considerations, and many other factors.

This architecture has two fundamental tenets. The first is that its ultimate goal is establishment of a human presence on Mars for science and exploration. The approach will seek to show that such a goal is possible within the next 50 years. The second tenet is that this goal requires a stepping-stone approach within which the necessary capabilities are gradually developed and evolved. We assert that a “brute force” approach that would jump directly to Mars from our current limited human capability in low-Earth orbit is untenable, and that the annual investment and mission risk required for such a leap are simply too great to be tolerable in today’s environment. Within these tenets we have established several guiding principles that help to define the overall architecture:

- 1.) *Goal-driven*: Include only those destinations that are scientifically and culturally compelling and for which human capabilities are both suitable and beneficial.
- 2.) *Separate cargo and crew*: Maximize efficiency and crew safety by focusing transportation tasks. Minimize crew flight time by off-loading heavy cargo and scientific equipment onto dedicated cargo vehicles, sent in advance of the crew for rendezvous at the destination.
- 3.) *One major new development per destination*: Establish a sequence of destinations and missions such that only one major new capability is required for each step, coupled with evolutionary progress in existing capabilities.
- 4.) *Emphasize use of existing transportation tools*: Require no fundamentally new and expensive propulsion systems or launch vehicles. Rely instead on proven technologies and on astronaut capabilities for in-space assembly and fueling of reusable systems.

We apply these principles to develop a logical series of steps that will lead humankind progressively deeper into the solar system and ultimately to Mars, with significant scientific discoveries possible at every destination along the way. While we have selected a set of destinations we feel are the most important, we also identify alternative or additional destinations whose inclusion may be debated as the program develops. For each step we identify in concept the major developments that are required, and we also articulate a strawman mission scenario. The latter is intended merely to illustrate the types of activities in which human explorers may be engaged, with an eye toward identifying important capability developments. The table below summarizes the primary architectural steps.

Step	Destination	Major New Capability	Alternative/Additional Destinations
1: Beyond LEO	Sun-Earth L2, Moon	Geospace Exploration Vehicle	Highly elliptical Earth orbit Earth-Moon L1, L2
2: Deep Space	Near-Earth Objects	Interplanetary Exploration Vehicle	Deep space test flight
3: On to Mars	Phobos/Deimos	Cargo Transport Vehicle	Mars orbit
4: Down to Mars	Mars surface	Mars descent/ascent system and surface habitat	None

Step 1: Beyond Low-Earth Orbit

One very attractive initial human destination beyond low-Earth orbit is the Sun-Earth L2 libration point (SEL2). This is not only the preferred location for many of the large telescopes that will study the universe and extra-solar planets, it is also an energy-efficient “gateway” for staging of vehicles and cargo prior to departure for more distant solar system destinations. Astronaut activities at SEL2 will emphasize construction and maintenance of precision telescopes, capitalizing on human problem-solving skills and manual dexterity that will not be equaled robotically for a long time, if ever. Only modest mission durations will be required, well within today’s database of human space flight. Most importantly, the capabilities developed for working at SEL2 will directly contribute to our ability to eventually reach and explore Mars.

The other candidate as an initial destination is the Moon. There are a number of important scientific and cultural reasons for a human return to the Moon, and international interest in lunar exploration is high. We do not claim to have done a rigorous technical comparison of the Moon vs. SEL2 as the most effective starting point for a long-term human exploration program. Rather, since lunar exploration concepts have been addressed in many other studies, we have elected to identify SEL2 as the primary initial step beyond LEO so that we may explore the characteristics of an architecture that develops from that starting point. Future work should include a more in-depth comparison, focusing on the scientific benefits of each destination and the contributions to the eventual goal of Mars exploration. It is entirely possible that ultimately it will be deemed important to include early missions to *both* SEL2 and the Moon, in order to best advance science and to establish a robust human exploration capability. In that regard, it is encouraging to note that a single new vehicle, which we call the Geospace Exploration Vehicle, would be suitable for missions to both destinations.

Reaching Sun-Earth L2

Sun-Earth L2 is in the anti-Sun direction about 1.5 million km from Earth. Since it is merely a point in space geometrically coupled to Earth, instead of a physical orbiting body, launch can be virtually any time and all launch opportunities offer approximately equal performance. ΔV costs for fast transfers to the Sun-Earth L2 point are shown on the graph, and from this figure it is evident that ΔV costs increase rapidly for one-way flight times under two weeks. As a benchmark for vehicle sizing we select a 30-day round-trip flight, for which the ΔV cost at L2 (total for both arrival and departure) is approximately 1800 m/s. Thus the total ΔV including the

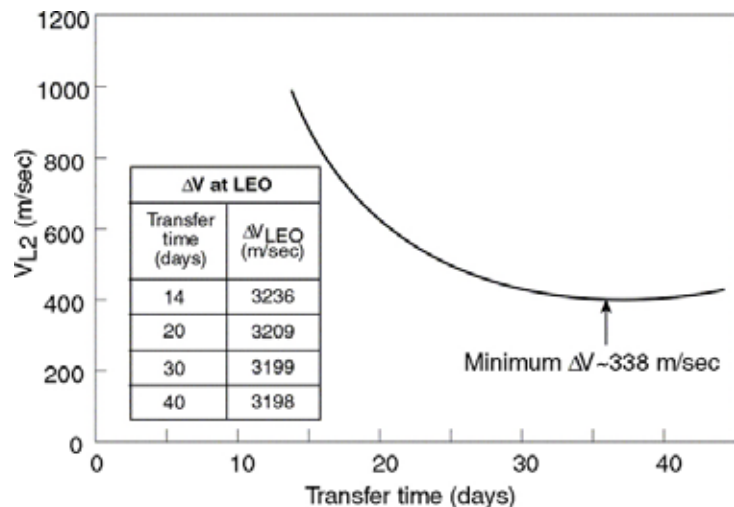

One-way fast transfers from low-Earth orbit to the Sun-Earth L2 point. The ΔV cost to depart SEL2 and return to Earth is about the same.

Earth departure maneuver is about 5000 m/s. We add an additional 1000 m/s for margin and mission contingencies, for a total ΔV for piloted missions of 6 km/s. This is compatible with a transfer time of 15 days each way, to which we add 15 days on station at SEL2 and 5 days contingency, for a total mission duration of 50 days. Shorter mission durations can be achieved, if desired; for example, shortening the return trajectory by 5 days can be done at a cost of about 600 m/s. This could come out of the 1000 m/s ΔV reserve if needed.

Mission Scenario

The primary objective for human missions to SEL2 will be telescope assembly and servicing. Most of the large telescope elements will probably be sent to SEL2 robotically using low-energy trajectories, and inserted into halo orbit prior to departure of the crew. The crew will travel to SEL2 aboard the Geospace Exploration Vehicle (GEV), the core of which will be robotically emplaced in LEO prior to launch of the crew. One key feature of the GEV is an Apollo-style Earth return capsule that the crew will use at the end of their mission; the crew may also travel from Earth's surface to LEO in this capsule and mate it with the GEV core prior to departure for SEL2. A separate cargo launch may be used to deliver fuel and equipment into LEO, which the crew will use to supply the GEV prior to departure for SEL2.

We have assumed that the crew will nominally have 15 days at SEL2 to assemble and service telescope elements, but this is certainly an open design parameter. Robotic assistants and small "fetch" vehicles may be developed to help the crew access telescope elements and work on them efficiently. SEL2 provides a benign environment with ample solar power and constant communications with Earth, so operations can be conducted with full participation from ground controllers. An added advantage is that objects at SEL2 are relatively stable; they will remain in their halo orbits relatively unchanged for up to 3-4 months without orbit maintenance.

Following their mission, the crew will depart SEL2 aboard the GEV and enter an Earth-return trajectory. Some days before Earth arrival the crew will enter the Apollo-style capsule for direct Earth entry. The velocity upon return from SEL2 is not substantially different from the velocities encountered during return from lunar missions. The GEV will then robotically transfer back into LEO, using a combination of aerobraking and small propulsive maneuvers. Since the crew is no longer aboard and flight time is not an issue, aerobraking can be done gradually to save propellant mass. This provides an efficient means of re-using the high-value GEV with minimum risk to the crew.

Sun-Earth L2 Mission Scenario

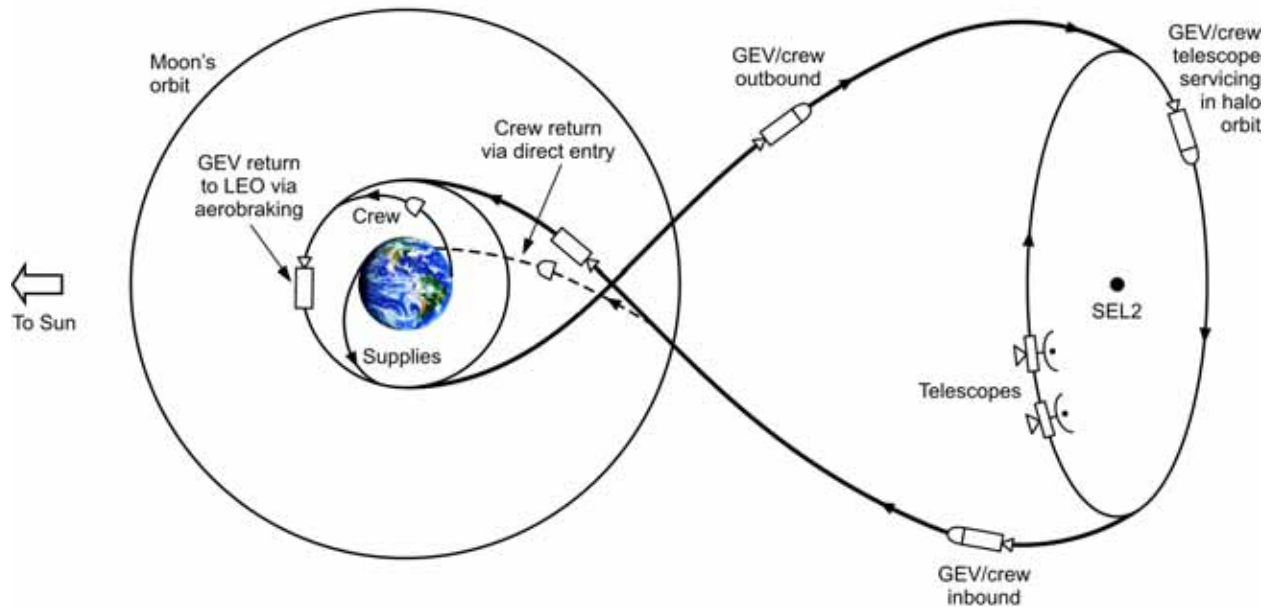

Mission scenario for SEL2 telescope assembly and servicing (not to scale). After attaching their capsule to the GEV and loading cargo, the crew travels to SEL2 to rendezvous with telescope elements previously emplaced in halo orbit. Upon return to Earth, the crew capsule separates and directly enters the atmosphere while the GEV core is robotically transferred back to LEO for re-use.

After parking in LEO, the GEV will await its next crew. That crew will need to re-supply and re-fuel the GEV, including attaching their own crew return capsule, prior to their mission. This mission scenario capitalizes on the significant capabilities of astronauts for EVA and in-orbit assembly, both for preparation of the GEV in LEO as well as for telescope assembly and servicing at SEL2.

Destination Moon

Missions to the Moon require many of the same capabilities as do missions to SEL2, but they also require emphasis on descent/ascent and surface exploration capabilities. Given the vast differences between the lunar and Martian environments, it is debatable to what degree the development of tools and habitats for the Moon will provide substantial benefits to eventual Mars exploration. The Moon is a destination with important scientific and cultural benefits that make it worthy of human exploration, but from a technical standpoint it is not necessarily in the critical path to Mars.

If a decision is made to include the Moon in a human exploration program, it will be important to emphasize commonality of design so that developments can be applied to future destinations. The GEV defined earlier is very well suited to lunar exploration as well as to SEL2 missions. The ΔV capability, crew complement, life support capabilities, and Earth return scenario could all support a very robust multi-mission exploration capability. The GEV would be the

workhorse vehicle for repeated trips to lunar orbit, where it would rendezvous with a robotically-transported, reusable Surface Excursion Vehicle (SEV). The SEV would be stationed in lunar orbit to support multiple surface missions, and would be refueled either robotically or by each lunar mission crew when they arrive. In the long term, refueling of the SEV using lunar-derived propellants would greatly reduce mission mass requirements.

Lunar Mission Scenario

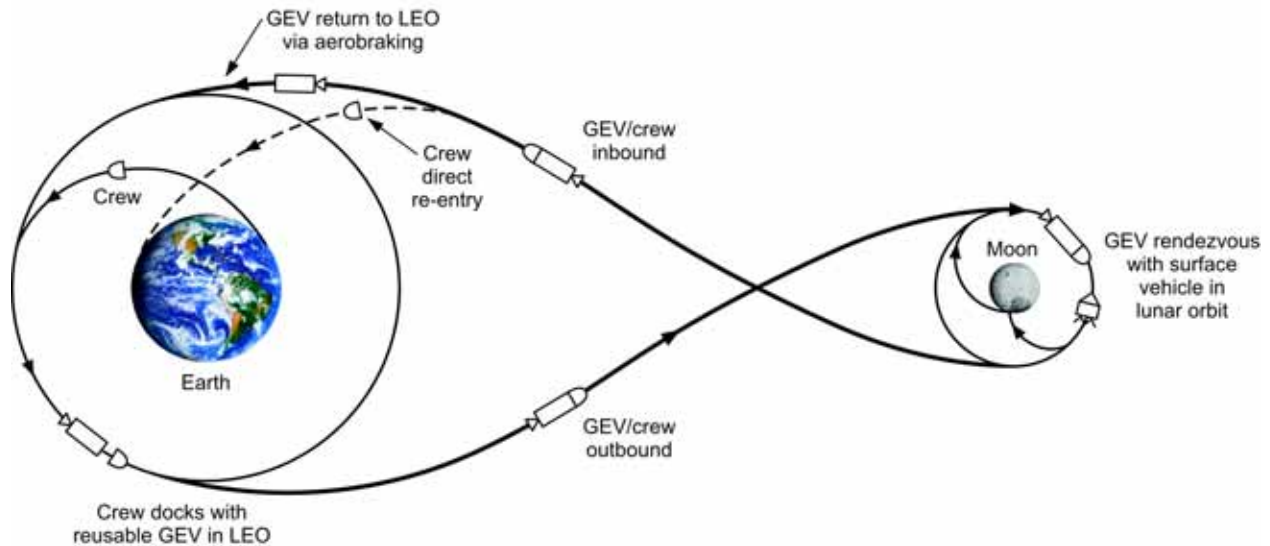

Lunar mission scenario schematic (not to scale). After mating their capsule with the GEV in LEO, the crew travels to lunar orbit to rendezvous with a robotically emplaced lunar descent/ascent system. Following the surface mission, return to lunar orbit, and rendezvous with the GEV, the crew returns to Earth for direct atmospheric entry. The GEV is robotically transferred back to LEO for re-use.

Elements of the SEV and other lunar mission assets will represent technological progress toward the ultimate goal of human Mars missions. In particular, the development of a human-rated chemical propulsion system for lunar descent/ascent, on-orbit and surface refueling, precision landing systems, lightweight habitats, and surface mobility systems may serve as precursors to Mars mission capabilities.

The fact that the Moon always presents the same face toward Earth both aids and hinders lunar exploration. Near-side lunar missions are simplified because they have direct access to Earth-based control centers, but farside lunar operations will require a satellite communications link with Earth. In 1966, Farquhar showed that it would be possible to establish a continuous farside communications link using a single comsat in a halo orbit around the translunar libration point EML2, as shown in the figure.

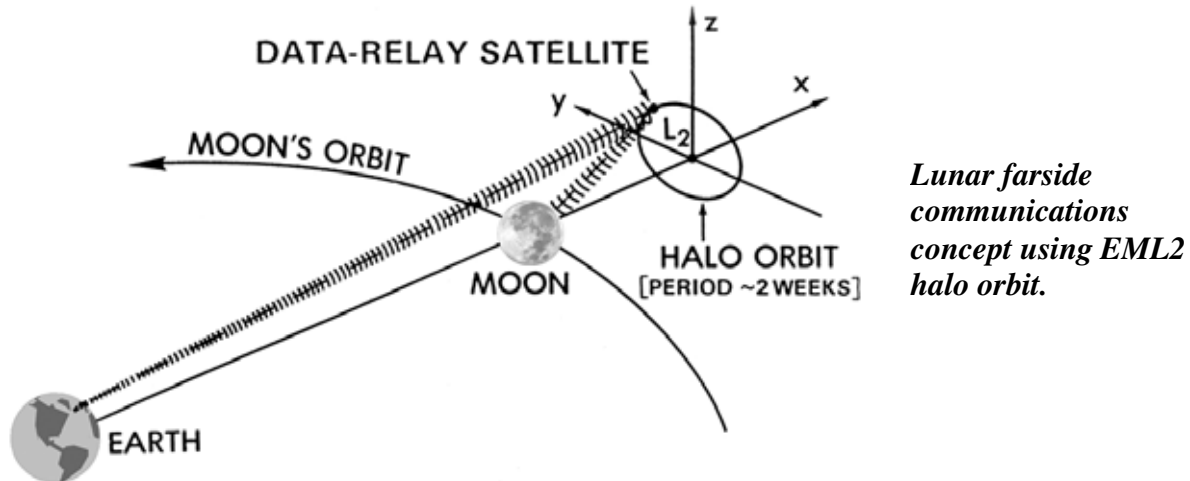

The EML2 halo orbit has also been proposed as a staging node for a lunar transportation system. If a permanent human base were to be established requiring frequent missions to the Moon, such a staging concept might provide an efficient and flexible way to maintain this base. If the flight rate to the Moon is just one or two missions per year, however, the standard Apollo-style lunar orbit rendezvous using the GEV would likely be the most cost-effective approach.

Capabilities and Infrastructure

A number of important capabilities will be required to enable this first critical step beyond LEO, whether the destination be SEL2 or the Moon. Among them are:

- Crew access to destinations (via the Geospace Exploration Vehicle)
- Crew return to Earth
- Robust rendezvous and docking capability
- Robotic assistants for assembly tasks
- Astronaut mobility/control during EVA
- Advanced spacesuits for dexterity, re-use, and maintainability
- Lightweight life support

The Geospace Exploration Vehicle will represent the most significant new capability and the largest single investment for Step 1. It will be the workhorse vehicle for missions to SEL2 or other destinations in Earth's neighborhood, including the Moon, and will play an important role in enabling missions to more distant destinations.

The Geospace Exploration Vehicle

The GEV will be designed to transfer astronauts from LEO to energetic destinations such as SEL2 or lunar orbit. It must be capable of up to 6,000 m/s of ΔV , mission duration of up to 50 days for SEL2 missions, and it must accommodate a crew of 3-7 people. The smaller crew sizes are consistent with longer missions to SEL2, and larger crew sizes may be appropriate when the GEV is used on a fast transfer trajectory to bring a fresh crew to lunar orbit or to an interplanetary vehicle prior to its departure.

Life support. The GEV must be adequately sized for 3 people for up to 50 days or up to 7 people for shorter durations. Crew accommodations will be somewhat spartan compared to that provided by the more spacious quarters of a space station habitat. Since mission durations are relatively short, life support systems will be straightforward and will probably require that H₂O is only minimally recycled via simple purification of hygiene water. Air revitalization to remove CO₂ may likewise be unsophisticated, with no attempt to recover O₂. During its missions, this vehicle will also serve as a testbed for the more sophisticated life support technologies to be used on interplanetary missions.

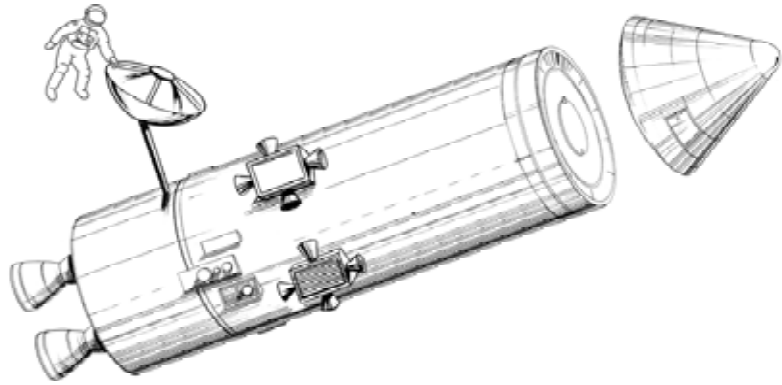

Schematic of a Geospace Exploration Vehicle. Key elements are highly reliable chemical propulsion and a detachable crew capsule, which is mated with the core prior to each mission and detached for crew re-entry. The combined capsule/GEV core provide living space for 3–7 crewmembers, depending on mission duration. This reusable GEV is conceived for use in an architecture in which crew and cargo travel separately to the destination, to minimize GEV volume, mass, and flight time.

Propulsion. The GEV will use highly reliable chemical propulsion and can be based on today's technology. The vehicle will be designed for re-use, either through replacement of expended fuel tanks (drop tanks) or through more complex on-orbit refueling. It may be determined that use of a kick motor or other detachable propulsion module for departure from LEO yields better mass performance. In that case, the integrated propulsion system would then be used for orbit insertion at the destination and for Earth return. The GEV must be capable of piloted operation for rendezvous maneuvers at SEL2, and robotic operation for aerobraking and return to LEO.

Radiation protection. Human trips beyond LEO will subject the crew to a much more intense radiation hazard. During Apollo, a network of solar observing stations enabled forecasting of safe periods of travel for the relatively short-duration missions. Apollo command capsules and especially the lunar module had relatively thin walls that provided only partial protection. For missions to SEL2, however, the time periods are longer than the 27-day solar rotation cycle. As a result, embryonic zones of activity can develop behind the observable solar disk and pose a significant threat to the astronauts. Thus the GEV will need to include a means of providing radiation shielding to protect the crew against the possibility of high-flux, energetic solar particle radiation. This may be achieved by judicious placement of equipment to create a safe haven, and use of temporary measures such as protective suits which could be worn for the relatively short duration of an SPE event (generally less than 1 day).

The table below summarizes some key requirements and capabilities of the GEV.

Crew	3 (for SEL2 missions) to 7 (in “taxi” mode)
Mission duration	Up to approx. 50 days
Propulsion	Chemical; ΔV capability 6 km/s
Power	Solar, fuel cells
Earth return	Robotic aerobraking to LEO
Crew return	Apollo-style capsule

Other Developments

The table below summarizes key capabilities for *Step 1: Beyond LEO*. Specific performance goals for each capability must be derived based on detailed design studies, which we have not attempted to conduct. All parameters shown below are notional and are intended only to serve as a starting point for technical analysis.

Development	Function	Performance Goals
Geospace Exploration Vehicle	Crew transport to LEO and then to SEL2/lunar orbit	Launch on ELV, chemical propulsion $\Delta V \sim 6$ km/s, 50 day mission
Crew return capsule	Earth re-entry from LEO or Earth-approaching trajectories	Apollo-derived, ballistic, low mass, 2-10 day duration
Rendezvous/docking systems	Enable close approach of co-orbiting assets	Standardized, semi-autonomous, low mass and power, fail-safe
Robotic assistants	Integrated computing and tool handling for in-space assembly tasks	Tethered to or free-flying with astronauts: “extra pair of hands”
Individual maneuvering units	Astronaut mobility and safety during in-space tasks	Highly reliable, thrust must not degrade optical surfaces, allow access to co-orbiting assets within limited range
Lunar surface systems	Enable human lunar missions	Descent/ascent propulsion, habitats, surface mobility, power, telecom
Advanced spacesuits	Support EVA’s for complex assembly and lunar exploration	Lightweight, flexible, maintainable suits for repeated use in dusty environments
Life support	Crew health and comfort	Lightweight, partial closed-loop, 50 day mission capability

Role of Robotic Missions

Several robotic observatories are planned for SEL2 in the coming years. These will make important discoveries that will help to frame the science objectives and rationale for the types of large telescope constellations envisioned for the future. Since SEL2 is a relatively benign environment, there are no precursor missions required to ensure human safety and efficacy at that destination. It may be determined that some type of solar radiation early warning system, most likely a network of satellites placed between Sun and Earth, would help to protect astronauts at SEL2 by providing several days advance notice of large solar flares. In addition, continued research into the ability of humans to live and work in space for long periods is required. This research is being conducted today on the ISS and is an important element of any future human space exploration program.

Robotic precursor missions to the Moon can significantly enhance human exploration there. Scientific spacecraft can answer important questions that will help to frame the objectives to be addressed by astronauts, thus allowing us to plan to effectively use human capabilities when they arrive. Robotic missions can also contribute substantially to crew safety by assessing environments, mapping potential landing sites, and emplacing infrastructure. Some potentially important robotic precursor missions include:

- Global high-resolution mapping to help identify landing sites and potential resources. This includes remote measurement of key elements; topographic, temperature, and gravity field mapping; and subsurface radar for ice detection.
- Deployment of robotic mobile landers to search for scientifically interesting samples for return to Earth. These could be returned to Earth robotically to determine their significance prior to crew exploration of the region, or cached for later pick-up by astronauts.
- Deployment of robotic mobile landers to permanently shadowed regions of the Moon to sound for ice below the surface, drill for subsurface ice, and conduct *in situ* resource production experiments.
- Emplacement of infrastructure in a “robotic outpost” prior to arrival of human explorers. Assets might include habitat, power systems, communications/navigation satellite network and ground stations, resource production systems, etc.

A program that is intended to establish a regular or permanent human presence on the Moon, as opposed to occasional short-term forays, will benefit greatly from a well-planned and integrated program of robotic precursors.

Alternate Destinations

It could be determined that neither lunar nor SEL2 missions are affordable initial destinations beyond LEO. In that case, alternative destinations might be selected that are less scientifically compelling but that still provide some benefit on the road to Mars. For example, merely reaching from LEO to a higher Earth orbit, such as a highly elliptical Earth orbit (HEEO), would motivate important advances in human space exploration capability. This could also be scientifically useful if trade studies determine that an effective means of emplacing large telescopes at SEL2 is to construct them in HEEO (for example) and robotically transfer them to SEL2. The telescopes could also be robotically transferred back to HEEO for servicing when needed. We do not believe this to be the optimum scenario since the telescopes will consist of multiple very large, precision structures that are best developed and serviced on station at SEL2. However, this alternative could be selected if funding and programmatic issues do not allow development of the entire suite of capabilities required for human operations at SEL2.

Similarly, if a lunar mission scenario is envisioned but actual missions to the lunar surface are deemed too costly for the first step beyond LEO, initial human missions to an Earth-Moon libration point or lunar orbit could be selected instead. These would stimulate development of significant beyond-LEO capabilities, including the GEV, but would not require concurrent development of lunar surface capabilities. Astronaut in-space assembly could allow Earth-Moon L2 to be established as an efficient “gateway” for later missions to the lunar surface, with a

build-up of assets and infrastructure that would enable subsequent crews to conduct very capable and productive lunar surface missions.

Summary: Architecture Step 1

The critical first step in a long-term program of human exploration of the solar system is to finally get out of low-Earth orbit. In this architecture we have identified SEL2 as an initial destination that is both scientifically important and that leads naturally to the ultimate goal of Mars exploration. At SEL2, human skills for problem solving, telescope assembly, test, and repair can enable new observations of the universe and a potentially revolutionary search for Earth-like extra-solar planets. This would represent the first step on an evolutionary path toward development of a deep space transportation and life support infrastructure, and emphasizes capabilities for in-space assembly and construction that will be key to affordable Mars missions. Missions to the Moon provide many of the same opportunities for advancement toward Mars and are scientifically and culturally important, but they require development of surface exploration capabilities that may be substantially different from those required for eventual Mars exploration. Architectural trade studies should be conducted to determine the relative importance of SEL2 and the Moon for long-term human exploration of the solar system.

The most significant new development will be the Geospace Exploration Vehicle (GEV), a chemically-propelled spacecraft capable of carrying 3–7 people on missions lasting up to 50 days. Many of the other required advances are evolutions in existing capabilities for which at least first-generation systems have been developed for Space Shuttle and ISS operations. A set of GEV capabilities can be identified that will enable human missions to both SEL2 and lunar orbit.

Step 2: Into the Solar System

A major milestone in human exploration will come when people first venture to a destination that is not gravitationally bound to Earth. That did not happen during the Apollo era, and it will not happen during missions to SEL2 or other destinations in near-Earth space. While in itself this may be of little technical significance, it will represent an important cultural shift in our perception of the human species: it will be the time when we can truly say that our civilization has moved out into the solar system.

The most effective destinations for this step are the near-Earth objects (NEO's), also known as near-Earth asteroids. In addition to their scientific and resource value, as discussed previously, NEO's are ideally situated to provide an important stepping-stone to Mars. They are accessible with flight times that are intermediate between SEL2 and Mars, and will provide us with an opportunity to exercise many of the required transportation elements in a relatively low-risk manner. And if the first human mission to the Martian system is ultimately targeted to Phobos or Deimos, as this architecture suggests, a precursor mission to a near-Earth asteroid would allow demonstration of almost the entire mission at a destination closer to Earth, with ample solar power availability, high communications rates, and relatively short return-to-Earth flight times that provide an extra measure of safety.

While the GEV is proposed as the workhorse vehicle for missions in near-Earth space, it is not sufficient for human missions to interplanetary destinations. A new Interplanetary Transfer Vehicle (ITV) is required that will represent a major evolution of GEV capabilities. Like the GEV, the ITV will be reusable and designed for in-space assembly, refurbishment, and refueling. While the GEV will be stationed in LEO and will make excursions to SEL2 or lunar orbit, the ITV will be stationed at SEL2 and will use that gateway for energy-efficient trips into the solar system. The ITV will incorporate a crew return capsule for Earth entry, evolved to accommodate the higher entry speeds, larger crew size, and longer flight times required.

Reaching the Near-Earth Objects

It is estimated that there are at least 1500 NEO's with diameters about 1 km or larger, along with many more smaller objects. Given the diversity of available targets, we assert that it will not be difficult to find a suitable destination when the program is ready to take this step. As an example, the figure illustrates a one-year mission profile to near-Earth asteroid 1999 A010 with a launch in 2025, including a 60-day stay at the asteroid. This trajectory is typical of opportunities that occur regularly.

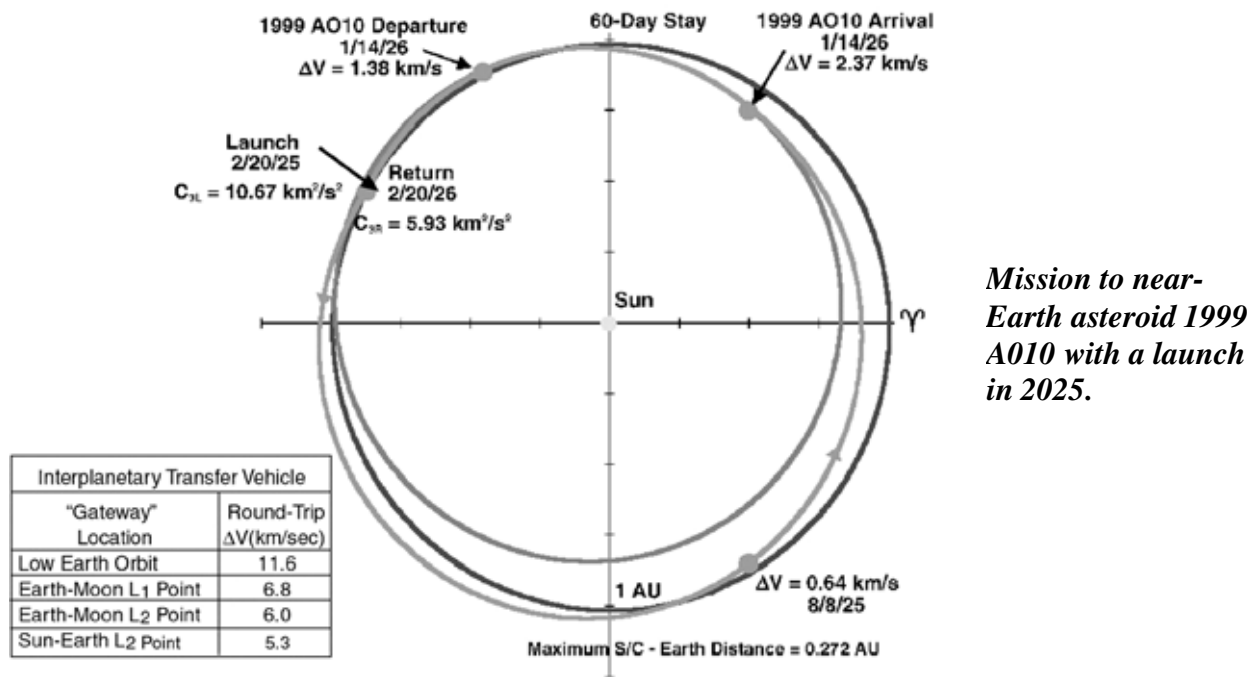

Mission to near-Earth asteroid 1999 A010 with a launch in 2025.

In the stepping-stone approach adopted by this architecture, the capability for regular operations at SEL2 is leveraged to help simplify journeys to more distant destinations. From the standpoint of celestial mechanics, SEL2 is an ideal gateway to the NEO's. The figure provides a comparison of ΔV requirements for this particular mission departing from a variety of staging locations. It can be seen that departing from SEL2 can reduce the total ΔV for this mission to only 5.3 km/s, which will provide significant mass benefits compared with departure directly from LEO. The primary reason for this mass savings is that we have "staged" the mission by investing energy to place a reusable spacecraft at SEL2, thereby reducing the incremental ΔV required to reach the target. At the staging node the vehicle can shed spent hardware (such as

motor casings) and be refueled so that the trip to the NEO is much more efficient. Starting the mission at SEL2 also allows the spacecraft to approach Earth and make its interplanetary injection burn at a relatively high speed and low perigee, further increasing fuel efficiency. Lunar swingbys may also be used to increase orbital energy and adjust phasing.

One of the guiding principles of this architecture is that crew and cargo should be sent to their destinations separately to enhance crew safety, minimize flight time, and allow use of existing launch vehicles. This will be a very important characteristic of missions to the Martian system, but it is not clear if it will be necessary for the Step 2 NEO missions. Given the low gravity of an NEO, there may not be much high-mass equipment required at the NEO; there will be no heavy descent stage, and the crew will use their interplanetary vehicle as a habitat during their rendezvous with the NEO. Excursions to the NEO surface can be made using enhanced EVA equipment and techniques. Other required equipment will depend on the mission's specific exploration objectives. Based on this, we assume that the first NEO mission will not require that a separate cargo vehicle be sent ahead of the crew, but that second-generation NEO missions might utilize that capability as their objectives become more sophisticated.

Mission Scenario

The core of the ITV will be delivered to SEL2 robotically, and over a series of robotic and human missions the ITV will be fully outfitted and prepared for flight. Astronauts at SEL2 will conduct both telescope servicing and ITV assembly tasks, the latter focusing on mating of sub-assemblies, propulsion modules, and the crew return capsule, and on testing of avionics and life support systems. Having completed those objectives, a final "servicing" crew would depart SEL2 for Earth on their GEV and the ITV would be robotically transferred out of its SEL2 halo orbit. A sequence of propulsive maneuvers and lunar swingbys would be used to very efficiently place the ITV into an elliptical Earth orbit, phased to coincide with the desired interplanetary departure asymptote.

Several days prior to the final planned perigee of the ITV's elliptical Earth orbit, an interplanetary mission crew would rendezvous with and board the ITV using a GEV in "taxi" mode. Only about 4 km/s would be required for this in-transit rendezvous, well within the GEV's 6 km/s design specification. Upon reaching the final perigee, the ITV will perform its injection burn to depart for the asteroid destination. The fuel efficiency of this maneuver is greatly enhanced by performing it at perigee of a highly elliptical Earth orbit. If final checkouts indicated that all systems were not ready for departure, that burn would be delayed and the ITV would remain in a highly elliptical Earth orbit. The burn could be done at a subsequent perigee, or if the problems were serious the crew could depart the ITV and return to Earth. In that case the ITV would be robotically transferred back to SEL2 for repair and later use.

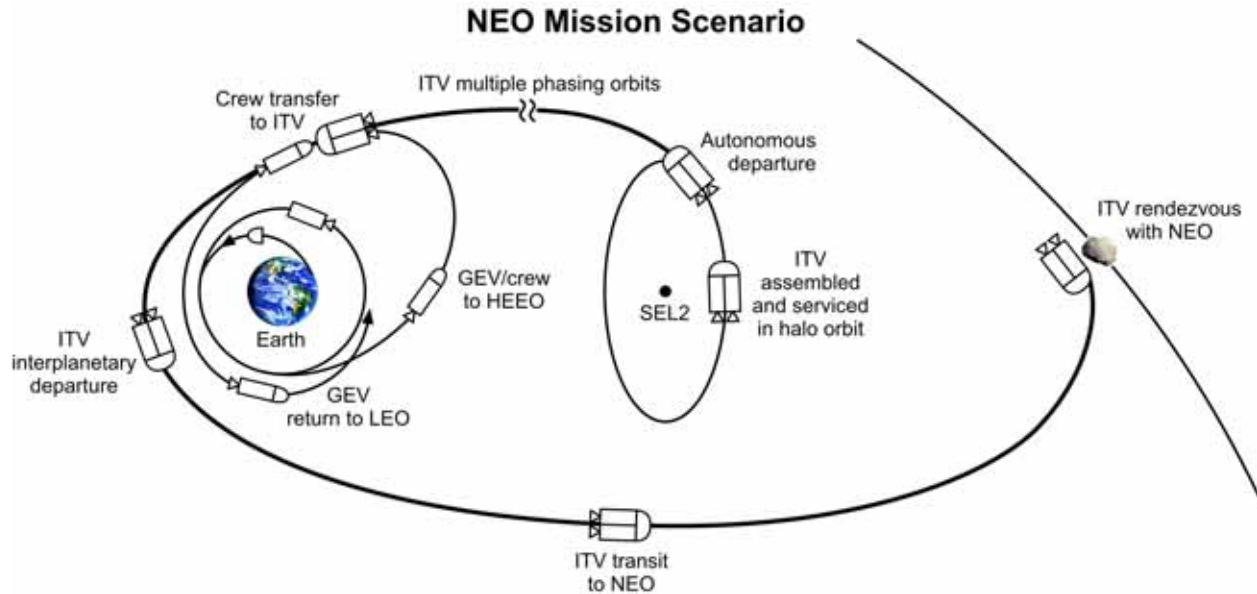

NEO mission scenario (not to scale). This represents a general strategy for interplanetary mission departures using an ITV stationed at SEL2. Elements of the ITV would be robotically emplaced at SEL2 using highly efficient trajectories, and would be assembled and prepared by crews who may also conduct telescope assembly and servicing tasks. After departing SEL2 and robotically flying multiple Earth orbits for phasing, a crew would board the ITV using a GEV in “taxi” mode and would depart for the NEO or other planetary destination. The GEV taxi would robotically return to LEO for re-use.

This scenario represents a highly efficient means of departing near-Earth space for an interplanetary destination, without subjecting the interplanetary crew to additional flight time in Earth orbit. It leverages the capability of the GEV for operations near Earth to reduce the propulsion requirements on the ITV, thereby enabling use of highly reliable chemical propulsion and reducing interplanetary flight time. It also builds on the astronaut capabilities for in-space assembly and repair, developed initially for telescope servicing but later applied to preparation of the ITV. Both activities take advantage of the unique characteristics of SEL2. In this exploration architecture, this building-block approach to Earth departure will be utilized for all human interplanetary missions.

Upon arrival at the destination, the ITV will rendezvous with the NEO at a safe distance. Crew will live aboard the ITV and travel to the NEO surface using small vehicles or maneuvering units, where they will conduct their science and exploration activities. Since the NEO is a micro-gravity environment without atmosphere, little specialized equipment will be required; many of the tools developed for use at SEL2 will be usable with minor modifications. After completing the interplanetary mission, the ITV will transport the crew to the vicinity of Earth where they will re-enter directly in the enhanced crew return capsule. The ITV (sans crew) will then use a perigee ΔV maneuver for Earth capture followed by lunar gravity-assists and small propulsive maneuvers to return to the SEL2 gateway. It will remain at SEL2 to be refurbished by a later crew in preparation for another interplanetary mission.

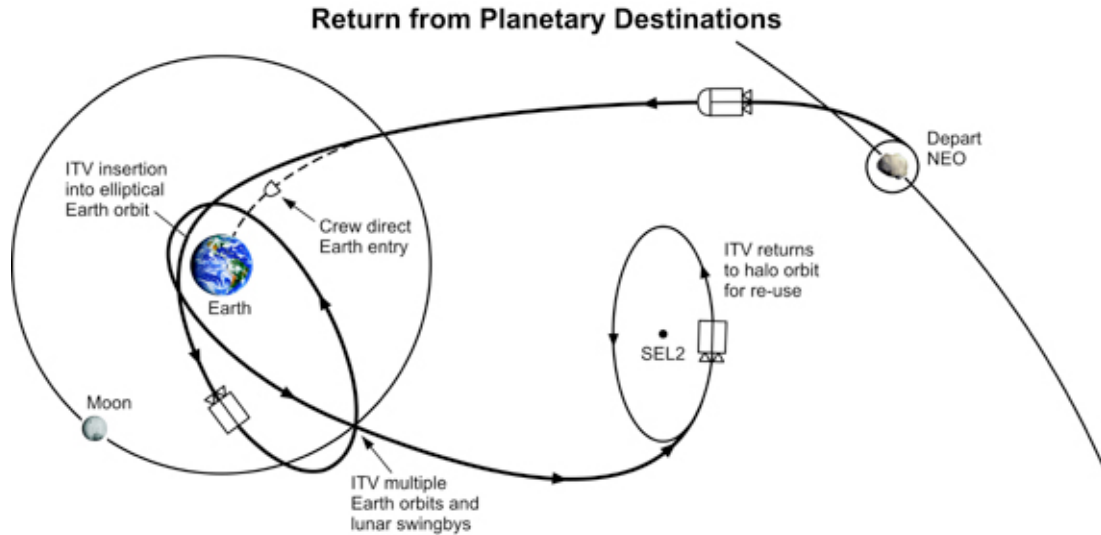

Schematic of return to Earth (not to scale). Upon return from NEO's or another planetary destination, the crew will directly enter Earth's atmosphere and the ITV will be robotically transferred back to SEL2 for re-use.

Following this first-generation NEO mission, more extensive NEO exploration, mining, or other commercial activities may be pursued. For those missions, it will probably be advantageous to send a cargo vehicle to the NEO in advance of the crew. This would help to keep the crew flight time to a minimum by keeping the crewed ITV at minimum mass. The cargo vehicle could be a modified version of the GEV or ITV, but one very attractive option would use highly-efficient electric propulsion (either solar or nuclear powered) to increase mass delivery capability. SEP/NEP are not good options for crew transfer because the flight times can be long, but they are ideal for cargo delivery, for which flight time is less important but mass efficiency is paramount. The large power generation capability of an electric propulsion cargo vehicle could also be very beneficial for the crew when they arrive.

Capabilities and Infrastructure

A mission to an NEO is effectively a mission to a point in deep space, because the target has very low gravity and no appreciable atmosphere. This means that much of the equipment developed for SEL2 operations will be directly applicable at NEO's, with the obvious need to evolve it as necessary to account for the larger distances to Earth and Sun and the increased mission duration. Significant developments for the initial NEO mission include:

- Interplanetary Transfer Vehicle (ITV)
- Enhanced crew return capsule (larger crew, higher entry speed)
- Life support capability for 1 year missions
- Crew mobility systems for asteroid surface exploration
- Robotic assistants and exploration tools

The ITV is most significant development that will be required for this step; this will represent a substantial investment and must be designed with the ultimate destination (Mars) in mind. The

1-year asteroid mission will provide an ideal opportunity to test and refine systems while conducting important exploration activities.

Interplanetary Transfer Vehicle

The Interplanetary Transfer Vehicle (ITV) is envisioned as a habitat for 5 to 7 astronauts on long-duration missions. Many of the systems will be adaptations of designs used in the GEV. An initial ΔV capability of about 6 km/s will be adequate for NEO missions, but the vehicle must have the capability to grow to about 8 km/s for Mars missions when sufficient margins are included. Lifetime must likewise be planned for up to three years, which is the expected maximum duration of a minimum-energy roundtrip to Mars. The ITV may be designed for robotic aerobraking upon arrival at Mars, but it will not be designed for aerocapture and thus will not require a heavy heat shield.

Life support. Extended time periods in space necessitate an extremely advanced life support system, with full recovery and recycling of >95% of all H₂O utilized, the extraction of O₂ from exhaled CO₂, and high filtration capacities to maintain purity of the environment and well-being of the astronauts. Such systems are a matter of life and death for the crew, so they must be designed for reliability and for ease of maintenance during the mission. Management of the microbial ecology of the habitat and human occupants will also be important for maintaining human health. The first-generation ITV will incorporate the full suite of life support technologies required for the ultimate Mars mission as part of the testing process.

Crew gravitational and radiation environments. Microgravity exposure is known to be generally debilitating to skeletal mass, muscle strength, and immune system robustness. Undoubtedly, many other bodily systems are affected, some with ramifications only poorly understood at this point in the history of space exploration. The use of artificial gravity as a countermeasure to microgravity has been proposed and subjected to sporadic study for more than four decades. Use of tethers or truss-works erected in space have been proposed as means of implementing rotating vehicles to produce artificial gravity. In this study we have not considered the application of artificial gravity in any detail. In keeping with the principles of this architecture, we seek instead to minimize crew flight time by separating crew and cargo, and clearly the ITV will need to incorporate the most advanced exercise and health maintenance tools

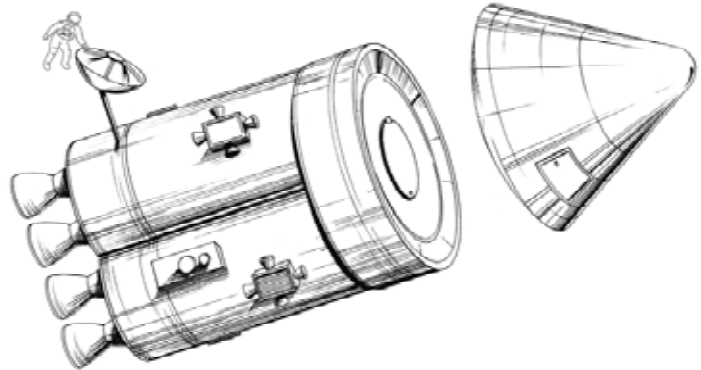

Schematic of an Interplanetary Transfer Vehicle. Patterned after the smaller GEV, the ITV will carry a crew of 5–7 on missions to NEO’s and Mars. The detachable crew capsule is larger and compatible with higher entry speeds, and the total ITV/capsule living space is nearly double that of the GEV. The reusable ITV will be stationed at SEL2 to maximize mass efficiency in a long-term exploration architecture.

available. Continued scientific study on the ISS during the coming years will focus on understanding the effects of the space environment on humans, and effective countermeasures may be found to enable an ITV design that does not require artificial gravity. This decision can only be made after significant additional research and technology development, and clearly represents one of the major open issues in any human space exploration architecture.

Radiation is also known to be a significant hazard during long-duration spaceflight, and the ITV will need to incorporate advanced methods of radiation protection. Research on the ISS in the coming years will provide an opportunity for much greater insight into the risks and effects, and early human missions to SEL2 and the Moon will serve to extend our knowledge base. We assume that some combination of intelligent ITV design, including radiation shielding, and medical countermeasures will be found sufficient to enable human deep space missions of up to 1 year for NEO's and up to 3 years for Mars round trips. Due to the obvious ramifications for the future of human travel beyond LEO, this is clearly one of the most important areas for research in the near term.

Propulsion. Chemical propulsion will be used for the ITV, at least in the early decades of the human exploration program. By following the guideline of separating crew and cargo, the ITV mass can be minimized so that no fundamentally new and expensive propulsion system is required. Chemical propulsion is a highly reliable and mature technology appropriate for use on a crew vehicle. Although there are certainly other propulsion technologies that can provide better performance, at least on paper, in our view the risk and expense of those developments would only serve to further delay the first human journeys into the solar system. Electric propulsion will be used for cargo vehicles for which flight time is less important.

Power. The ITV will use solar power and fuel cells to the maximum extent feasible. Continued research into lightweight solar arrays or concentrators will help to minimize ITV mass. It is possible that small radioisotope devices may also be used for heating or to provide additional power for certain critical subsystems. If an electric propulsion cargo vehicle is sent in conjunction with the ITV on an asteroid mission, the large power capability of the SEP or NEP system might be used to augment ITV power during the mission.

The table below shows some of the important ITV design parameters.

Crew	5 to 7
Mission duration	6–12 months for NEO missions, up to 3 years for Mars
Propulsion	Chemical; ΔV capability 6-8 km/s
Power	Solar, possibly augmented by radioisotope
Earth return	Robotic transfer to SEL2
Crew return	Enhanced Apollo-style capsule

Other Developments

The table below summarizes key capabilities for *Step 2: Into the Solar System*. Specific performance goals for each capability must be derived based on detailed design studies; all

parameters shown below are notional and are intended only to serve as a starting point for technical analysis.

Development	Function	Performance Goals
Interplanetary Transfer Vehicle	Crew transportation to/from NEO	Crew 5–7, 1-yr mission growing to 3 yrs, chemical propulsion 6–8 km/s, solar power
Enhanced crew return capsule	Crew final transport and Earth re-entry	Enlarged Apollo-derived capsule, crew 5–7, 2–10 day duration
Extended life support	Crew health for 6–12 month mission	Nearly complete H ₂ O recycling, O ₂ regeneration, enhanced micro-gravity countermeasures or artificial g
Crew mobility systems	Crew EVA for servicing and NEO exploration	Small “pods” or enhanced backpacks allowing crew to approach, land on, and explore NEO’s; 8–12 hour duration; integrated life support, propulsion, comm.
Exploration tools	NEO science and resource utilization	Advanced sensors for NEO internal structure and composition; prototype tools for automated mineral extraction and resource production; anchoring techniques

Role of Robotic Missions

Determination of the utility and importance of human exploration of NEO’s will rely on data from robotic precursor missions. So far, there have been only two robotic encounters with NEO’s, both within the last few years. The first began when the Near Earth Asteroid Rendezvous (NEAR) mission orbited Eros for one year, beginning in February 2000 and completing its highly successful mission with a landing on February 12, 2001. The second came when the Stardust spacecraft conducted a fast flyby of the asteroid Anne Frank in November 2002. Japan’s Hayabusa spacecraft (formerly MUSES-C), primarily a technology demonstration mission, was launched in May 2003 and is to return a sample of 1998SF36 in July 2007. Following that, there are no firm plans by any of the world’s space agencies for robotic missions to this important class of objects.

The current statistical survey of the orbits and observable properties of NEO’s larger than 200 meters in diameter will be conducted primarily from ground-based observatories, although a number of innovative orbital mission concepts, such as the ESA EUNEOS mission, have been proposed to increase detection sensitivity. Completing the inventory of NEO’s is an important step toward understanding Earth’s planetary neighborhood. Prior to any decision to proceed with human exploration of NEO’s, additional robotic missions will be needed to investigate their bulk chemical properties and diversity. This will enable us to understand the resource potential of this class of bodies and how they may behave as Earth impactors, and thus enable us to plan effective human missions possibly including hazard mitigation. Some of the key robotic mission steps may be:

- Deploy a fleet of small multiple-flyby robotic spacecraft to explore diverse types of NEOs. These spacecraft should include remote sensing and active experiments to collect small quantities of NEO material for on-board geochemical analysis.
- Deploy a set of robotic lander expeditions for surface exploration of a representative set of NEOs selected from the flyby survey. Some of these landers should include sample return.

These steps will enable us to determine how human explorers might pursue further science, Earth-impact mitigation, or in-space resource production objectives. Coupled with their nearly ideal location as intermediate steps between Earth and Mars, these objectives together could make the NEO's a very important destination in a long-term human exploration architecture.

Alternate Destinations

As a step toward Mars, NEO's appear to be ideal in terms of mission duration and complexity. They provide a destination that is scientifically useful and engaging to the public, with the added benefit of some commercial potential. Furthermore, they are an important class of object to evaluate as a serious Earth impact threat. If it is determined, for cost or programmatic reasons, that a mission to an NEO is not desirable, it may be decided instead to test the new flight systems during a "shakedown cruise" of 6-12 months in deep space. One potentially interesting and low-risk example of such a mission would be a flight out of the ecliptic plane, which could be designed so that the spacecraft would always stay at about 1 AU solar distance and would re-encounter Earth in 6 months with minimal propulsion required. Although this would not provide significant scientific opportunities, it would stress many of the same needed capabilities and could represent an important step toward the ultimate goal of reaching Mars.

Summary: Architecture Step 2

Humanity's first trip beyond the gravitational pull of Earth will be a major milestone in solar system exploration. Near-Earth Objects provide a large number of potential destinations for such a mission. These bodies are not only scientifically important, they are also potential resources to be used in space or on Earth, and they represent Earth impact threats that we must better understand. A trip to an NEO can be completed in about 1 year, providing an ideal context for development and test of systems that will eventually be needed for the longer trip to Mars.

Exploration of NEO's can be achieved through relatively straightforward evolution of much of the infrastructure developed for Step 1 of this architecture. The major new development is the Interplanetary Transfer Vehicle to carry the crew from SEL2 to the NEO destination and back to the vicinity of Earth. The ITV will rely on chemical propulsion and solar power, and will incorporate the same type of advanced life support systems that will be required for the later journey to Mars. Earth re-entry will utilize an enhanced Apollo-style capsule, and the ITV will be robotically transferred back to SEL2 for re-use.

Step 3: On to Mars

Having systematically developed the capability to live, work, and travel in deep space, the next logical step is to extend our reach all the way to Mars. This first journey of humans to another planetary system will represent another quantum leap in distance from Earth, mission duration, overall complexity, and cost. The foundation for this step must be laid very carefully during the preceding decades.

Our philosophy of incremental development as a means of managing cost and risk suggests that a human mission to one of Mars' moons, Phobos or Deimos, may be an important precursor to a

mission to the planet's surface. This enables continued adherence to the guideline of "one major development per step". A mission to Phobos/Deimos would utilize much of the infrastructure developed for the Step 2 NEO mission, with augmentations necessary for operation at Mars' distance from Earth. It would exercise all of the spaceborne elements of the ultimate Mars mission, including a robust cargo transportation capability, nuclear power, and rendezvous in Mars orbit, without simultaneously taking on the challenging Mars descent, surface activities, and ascent developments—arguably the most risky parts of the entire exploration architecture. It will provide an opportunity to conduct Mars science and emplace infrastructure on the surface with teleoperation from Phobos/Deimos, thus ensuring that the eventual human surface mission is that much more safe and productive. Finally it will allow for exploration of Phobos and/or Deimos, which are scientifically interesting in their own right.

A Phobos/Deimos mission may be perceived as an intermediate step that would unduly delay the first human presence on the surface of Mars. We suggest it not as an absolutely required element of the architecture, but rather as one with significant programmatic advantages that should be carefully and dispassionately considered. It may be especially important in the context of a long-term and *sustainable* human presence at Mars, which is the ultimate goal.

Reaching Phobos/Deimos

Mars launch opportunities occur roughly every 26 months, and typical fast flight times to Mars are 6–8 months. The moons of Mars are in roughly circular and equatorial orbits with periods of 0.3 (Phobos) and 1.3 days (Deimos). A spacecraft on a trajectory to Mars can rendezvous with one of the moons using a standard 3-burn strategy consisting of a Mars Orbit Insertion burn at closest approach to the planet, a maneuver to raise periapsis to the altitude of the target moon, and a circularization burn upon reaching that orbital altitude. The final step is simply a matter of adjusting phasing to rendezvous with the target. From arrival at Mars to rendezvous with one of the moons takes just a few days, and the additional ΔV cost is relatively small.

Mission Scenario

Piloted missions to Phobos/Deimos will follow the same Earth departure strategy used for the NEO missions. An ITV will be prepared at SEL2 and depart toward Earth; the interplanetary crew will board the ITV prior to perigee; and the Earth departure burn will be done at perigee to minimize propellant. The ITV will then fly the fastest possible trajectory to the Martian system, capture into Mars orbit using the 3-burn strategy described above, and rendezvous with the target moon. Although operating in Mars orbit, the mission scenario at Phobos/Deimos will be very similar to the NEO mission, in that the crew will live aboard the ITV while stationkeeping with Phobos/Deimos and will make forays to the moon's surface. In this case the surface stays may be longer, and it may be decided to establish rudimentary habitats or science stations on the surface. Mobility and exploration tools should also be quite similar to those used at the NEO's.

For missions to Mars and its moons, a Cargo Transfer Vehicle (CTV) using highly-efficient electric propulsion will be an important means of increasing mass delivery while allowing crew flight times to be kept to a minimum. Much of the exploration equipment and some consumables will be sent to the Martian system ahead of the crew, and it may be decided not to send the crew from Earth until the cargo has safely arrived at the destination. This strategy might

even allow the crew's Earth return propellant and supplies to be sent as cargo, further reducing the mass and flight time of the ITV on its way to Mars. Either solar electric or nuclear electric cargo stages may be used, and either could serve as a useful resource in Mars orbit. The presence of a fission power source in Mars orbit would be particularly beneficial and would provide the crew with a virtually unlimited supply of power for science and life support.

Also sent as cargo will be infrastructure and science equipment for robotic deployment on the Martian surface. These payloads could be guided to precise locations by the astronauts at Phobos/Deimos, and the crew could then control Mars science experiments and the establishment of a robotic outpost by tele-operation from Mars orbit. The removal of the light-time delay to Earth would make it feasible to actively manage experiments and react to discoveries, thus helping to define the role of humans when they eventually reach the surface. The Phobos/Deimos crew could also direct the establishment of habitats and robotic factories for production of propellant or other resources to be used several years later when the surface crew arrives.

After completing their mission, the crew will depart the Martian system on the ITV, possibly leaving behind their cargo vehicle as an asset to be used by the next crew. The ITV will fly a minimum flight time trajectory to Earth, and some days out the crew will board their capsule for direct Earth entry. The ITV will then be robotically operated for propulsive capture into elliptical Earth orbit and transfer back to SEL2 for refurbishment and re-use.

Robotic Outposts

The surface of Mars represents an area greater than the total land mass of Earth, and robotic exploration has shown that Mars possesses a great deal of geological diversity. Many unique and complex sites will be candidates for the first human exploration missions; selection of the optimum site will involve many individual criteria within the general categories of scientific return, safety, and accessibility. In order to fully characterize candidate sites it will be necessary to couple detailed orbital observations with the emplacement of multi-disciplinary robotic surface stations. Over a series of Mars opportunities, such "robotic outposts" will not only allow intelligent site selection, they will enable us to determine the most important scientific activities for human explorers and to fine-tune the suite of technical capabilities that they will need.

Once a site is selected, the robotic outpost will be expanded to include resource processing equipment, habitats, roving vehicles, and power and telecommunications infrastructure, all robotically emplaced and remotely operated from Earth or from Mars orbit. In this way a significant capability will be built up on the surface prior to the arrival of human explorers, greatly enhancing their safety and productivity and simplifying their journey to the Martian surface. The establishment of a robotic outpost on Mars is an important stepping-stone in a safe, affordable, and scientifically productive human exploration program.

Martian System and Phobos/Deimos Mission Scenario

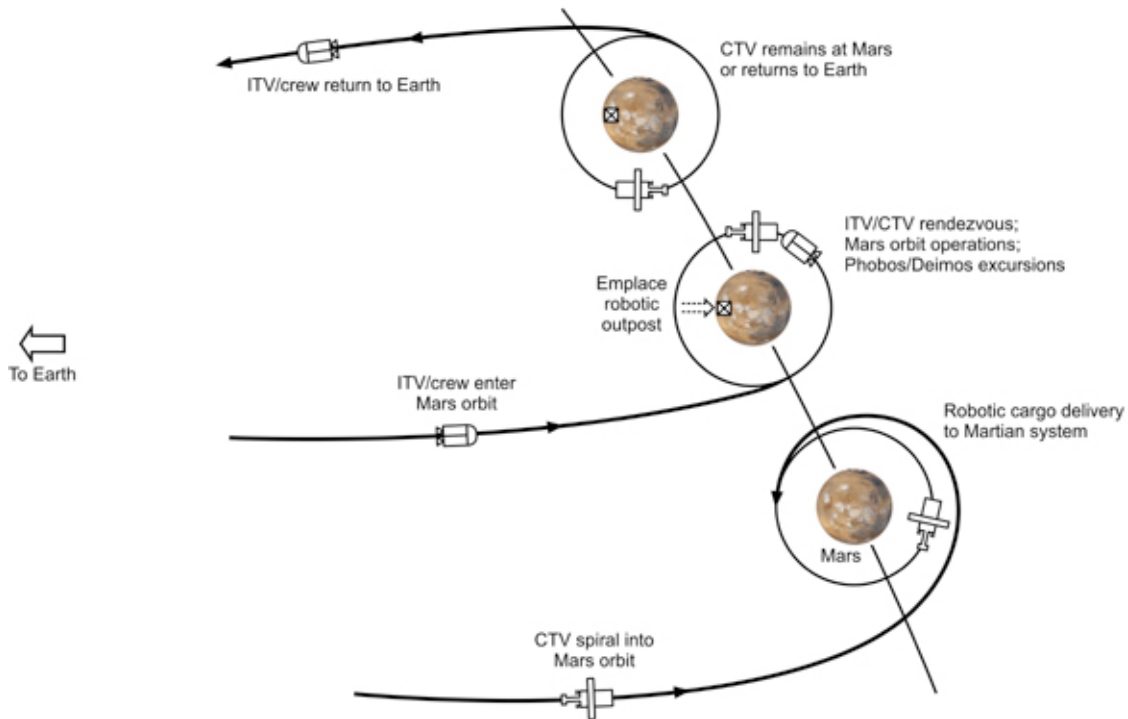

Schematic of activity in the Martian system. A Cargo Transfer Vehicle will be emplaced in Mars orbit near Phobos or Deimos in advance of the crew's departure from Earth. The ITV carrying the crew will rendezvous with the CTV and use the cargo to explore the Martian moon and to establish a robotic outpost on the planet's surface. Science activities will consist primarily of tele-operation of robotic science vehicles on the surface. Total crew stay time in the Martian system could range from several months up to about 18 months; the longer stay times generally require less ΔV and thus may be more compatible with the chemically-propelled ITV.

Capabilities and Infrastructure

Since the Phobos/Deimos mission has so much in common with the NEO mission conducted during Step 2, the vast majority of the infrastructure can be inherited and enhanced for the more distant destination. Developments that are new or represent significant evolution of prior capabilities include:

- Cargo Transfer Vehicle using SEP or (preferably) NEP
- Upgraded Interplanetary Transfer Vehicle (ITV) for 3 year mission
- Enhanced crew return capsule (higher entry speed)
- Life support capability for 3 year mission
- *In situ* resource utilization systems for robotic emplacement at Mars
- Mars surface experiments for tele-operation

Cargo Transfer Vehicle

The major new development for this step is the Cargo Transfer Vehicle. It is extremely important to minimize the mass burden on the ITV carrying the crew, so for missions to the Martian system as much equipment as possible should be sent separately for rendezvous with the crew in Mars orbit. This will enhance crew safety both by minimizing interplanetary flight time and by ensuring that critical assets are functioning at the destination prior to crew departure from Earth. The separation of crew and cargo is one of the guiding principles of this architecture.

Although traditional chemical propulsion systems can also be used to transport cargo, the higher specific impulse of electric propulsion makes it ideal for efficient transportation of large payloads that can be deployed well in advance of the crew. Mass-efficient but long flight time trajectories are undesirable for humans but are quite adequate for cargo payloads. Low-thrust vehicles are also ideally suited to departure from SEL2, because this location is at the edge of Earth's gravity well and thus time-consuming spiral trajectories are not required for Earth escape. Detailed descriptions of low-thrust trajectories to and from SEL2 are given by Kawaguchi and Yoshimura.

Recent progress in electric propulsion, especially in demonstrating long-duration ion propulsion on the Deep Space 1 and SMART-1 missions, confirm its value and technological maturity for future applications. In addition to SEP, NASA's Project Prometheus is developing nuclear electric propulsion (NEP) to be demonstrated on the Jupiter Icy Moons Orbiter mission. Such a system would be ideally suited to robotic cargo transportation. The CTV should be designed for modular increase or decrease in payload capability and for a variety of payload sizes and shapes. In-space mating of the cargo to the propulsion module of such a system is an architectural approach that offers broad and powerful flexibility. Even the propulsion unit can be sub-modularized so that two-engine clusters, complete with power conditioning and control equipment, can be incrementally added to achieve any capability needed for a large range of payloads.

Using either SEP or NEP to efficiently deliver large masses into Mars orbit well in advance of the crew, overall mission productivity and crew safety can be significantly enhanced without

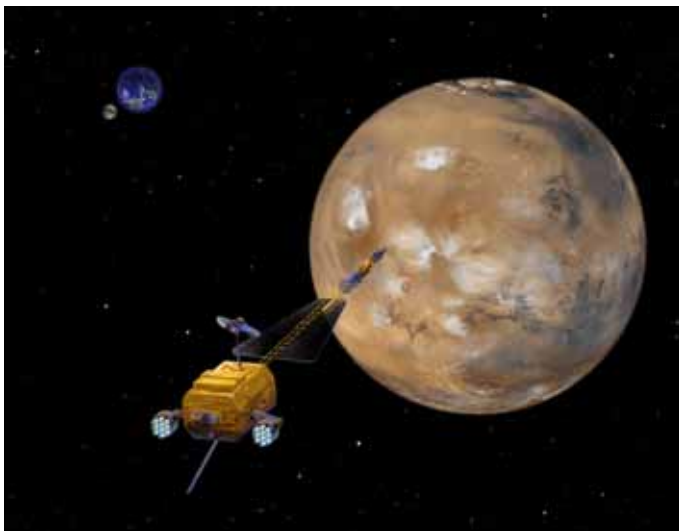

Artist's concept of a Cargo Transfer Vehicle approaching Mars. Such a vehicle could be based on the same nuclear electric propulsion system being developed to enable revolutionary robotic science missions such as the Jupiter Icy Moons Orbiter. A robust cargo delivery capability is a key element of a sustainable human exploration program.

increasing crew flight time or relying on expensive and risky new propulsion technologies. SEP and NEP are under development now for robotic space science missions, and these investments should be leveraged to the greatest possible extent to enable cost-effective human exploration missions.

Other Developments

The table below summarizes key capabilities for *Step 3: On to Mars*. Specific performance goals for each capability must be derived based on detailed design studies; parameters shown below are notional and are intended only to serve as a starting point for technical analysis.

Development	Function	Performance Parameters
Cargo Transfer Vehicle	Robotic cargo transportation from Earth's neighborhood to Mars orbit	SEP or NEP with advanced EP thrusters
Upgraded ITV	Crew transportation from Earth's neighborhood to Mars orbit	3 year mission duration, chemical propulsion 8 km/s, advanced life support,
Upgraded crew return capsule	Crew descent to Earth from interplanetary trajectory	Entry at up to 14 km/s, crew 5-7, life support for ~5-10 days
Enhanced life support	Crew health maintenance and monitoring	Re-generative system, 90-95% closure for O ₂ and H ₂ O, 3-year duration, low mass
<i>In situ</i> resource utilization	Propellant and resource production	Robotic emplacement on Mars, automatic operation, solar or RTG powered, produce and store propellant, H ₂ O, O ₂ ; communicate status
Mars robotic outpost	Explore and prepare site for human explorers	Detailed characterization of local environment, establish habitats, resources, telecom and power systems prior to human arrival

Role of Robotic Missions

Human exploration of the Martian system will benefit greatly from the intensive robotic exploration that is in progress now and will continue for the foreseeable future. These will result in a comprehensive foundation of knowledge that will greatly facilitate the first human missions. In the future, robotic missions will gradually begin to emplace local infrastructure in a robotic outpost. In particular, prior to a human mission to Phobos/Deimos robotic missions may be used to determine the radiation hazards for the round trip to Mars and to emplace an appropriate set of support satellites for video-rate communications relay and for navigation. It may also be important to have robotically mapped the topography and geochemistry of Phobos and/or Deimos, and to have returned a sample of each Martian satellite to Earth for scientific analysis.

One of the tasks for humans in Step 3 will be to operate robotic vehicles on the planet's surface, both for science and for establishment of the robotic outpost on Mars. Consideration should be given to returning Mars surface samples, which could be robotically acquired and launched into Mars orbit for the crew to retrieve and return to Earth. These could allow more detailed characterization of the surface composition at the prospective human landing site.

Alternate Destinations

It may be determined that the programmatic and scientific advantages of a Phobos/Deimos mission as a step to Mars do not justify the cost. In that case, one possible alternative would be

to conduct a mission to Mars orbit instead. This would still allow many of the desired programmatic objectives to be achieved, such as emplacement of infrastructure on the Martian surface and tele-operation of science experiments, and would parallel the Apollo strategy of conducting a mission in lunar orbit prior to descent to the surface. A more dramatic simplification could be achieved by making this initial step in the Martian system a purely robotic one, emphasizing emplacement of assets in Mars orbit via cargo flights and establishment of a more limited robotic outpost on the surface. This would not fully exercise the crucial life support and crew Earth return components, however, and thus would leave some major cost and risk elements untried until the ultimate Mars surface mission.

Summary: Architecture Step 3

In Step 3 we will undertake humankind's first journey to another planetary system. In order to lay the groundwork for a sustainable and productive human presence on Mars, a mission to one of Mars' moons may be a logical precursor. This would entail operation of all of the deep space elements that will be needed for Mars exploration at their full level of performance, and will build directly on the infrastructure that was developed for the SEL2 and NEO missions undertaken in Step 1 and Step 2 of this architecture. This would be done while developing in parallel the challenging Mars descent/ascent and surface systems, thereby helping to keep annual program costs as low as possible. The Phobos/Deimos mission would provide an excellent opportunity for tele-operated Mars science and pre-emplacment of infrastructure in a robotic outpost, and would lay a solid foundation for later human surface exploration.

In addition to the significant evolutions required for the ITV, life support, and exploration equipment, the major new development for Step 3 is a Cargo Transport Vehicle. The CTV would use SEP or NEP to increase mass delivery capability and would become an asset in Mars orbit of significant benefit to the crew. Much of the heavy exploration equipment to be sent to the surface of Mars would arrive in the CTV, possibly even including important consumables or Earth-return systems for the crew. For added safety, successful arrival of the CTV could be verified before the crew ever departs from Earth.

Step 4: Down to Mars

Virtually ever since it was discovered, the planet Mars has been a special place to humankind. For centuries it has been a centerpiece for much of our scientific speculation and imagination, and it has been explored more intensively than any other body in the solar system except Earth. The ongoing robotic Mars exploration program will continue to reveal much about its past and future, and especially about the possibility that it may once have been a habitat for life. In many ways, establishing a human presence on the planet Mars will represent the ultimate fulfillment of our destiny in space.



Humankind has already embarked on an intensive, long-term program of Mars exploration. It is only a matter of time before human explorers join their robotic counterparts on the Red Planet.

In the fourth and final step of this exploration architecture, humans will for the first time set foot on another planet. Human exploration of Mars will help to fulfill the overall Mars exploration strategy, focused on understanding the history and evolution of the planet, its biological potential, and the possibility that life actually developed there. The many failed attempts to craft a supportable human mission to Mars have shown that the objectives must be much more compelling than simply planting a flag and returning home. Our journey to Mars must be part of a logical, long-term program of exploration and science; it must be dedicated to opening a new frontier and to answering compelling questions of burning interest to scientists, the public, and the international community.

This architecture gradually builds capability to explore the solar system through a series of carefully selected steps, each one designed to eventually enable humans to reach the Martian surface. This by no means implies that the first human mission to the planet will be easy. Even with the significant investments made in the earlier steps, this fourth and final step will be the most challenging, and the time at which we will be ready to undertake it is uncertain. Ultimately it will be the continuing sense of exploration, along with the scientific discoveries and technical progress of the preceding steps, which will sustain public interest and international political support and make human presence on Mars a reality.

Reaching Mars

The trajectory strategy for reaching Mars will be virtually identical to the strategy described for the Step 3 mission to Phobos/Deimos. A chemically-propelled ITV will depart from SEL2 on the fastest feasible trajectory to Mars (approximately 6–8 months), and will be inserted into Mars orbit. Aerobraking may be used to reduce the propellant load. There it will rendezvous with an NEP Cargo Transfer Vehicle sent previously, and the crew will conduct their mission in Mars orbit and on the surface. Much of their activity will be focused around the robotic outpost emplaced during earlier missions. Following the mission, the ITV will fly the fastest possible trajectory back to Earth, with the crew employing the usual strategy of direct return in a re-entry capsule while the ITV is robotically transferred back to SEL2 for re-use or to LEO for decommissioning. Total mission duration for most opportunities will be about 3 years.

One possible mass-saving option is to make use of the Sun-Mars collinear libration point upon arrival at Mars, a mission concept identified by Farquhar in 1969. In this concept, the ITV would operate between the Sun-Earth and Sun-Mars collinear points, leading to further

reductions in the ΔV for the ITV. Further trade studies are necessary to better understand the trade-offs of mass and operational complexity for this or any other mission scenario.

Mission Scenario

The interplanetary strategy is identical to that followed for Step 2 and Step 3. In this case a significant amount of exploration equipment and infrastructure will have been pre-emplaced by prior missions and a functioning robotic outpost should be awaiting the crew on the surface. Upon arrival in the Martian system, the ITV will rendezvous with the Cargo Transfer Vehicle to gather assets for the descent to the surface. One or more CTV's will have carried a significant amount of high-mass equipment, including the Mars descent/ascent vehicle and its propellant. This might also include the surface habitat, or it might be emplaced on the surface during a previous mission.

The crew will transfer from the ITV to the descent vehicle, land near the robotic outpost, and prepare it for their surface stay. The crew will be composed of scientists and explorers, and must be provided with the scientific and exploration tools to make their time on the Martian surface safe and productive. We can only speculate as to what those tools are and exactly what types of experiments they will perform; those decisions will be made over the coming decades, informed by progress in the robotic Mars exploration program.

Mars Surface Exploration Mission Scenario

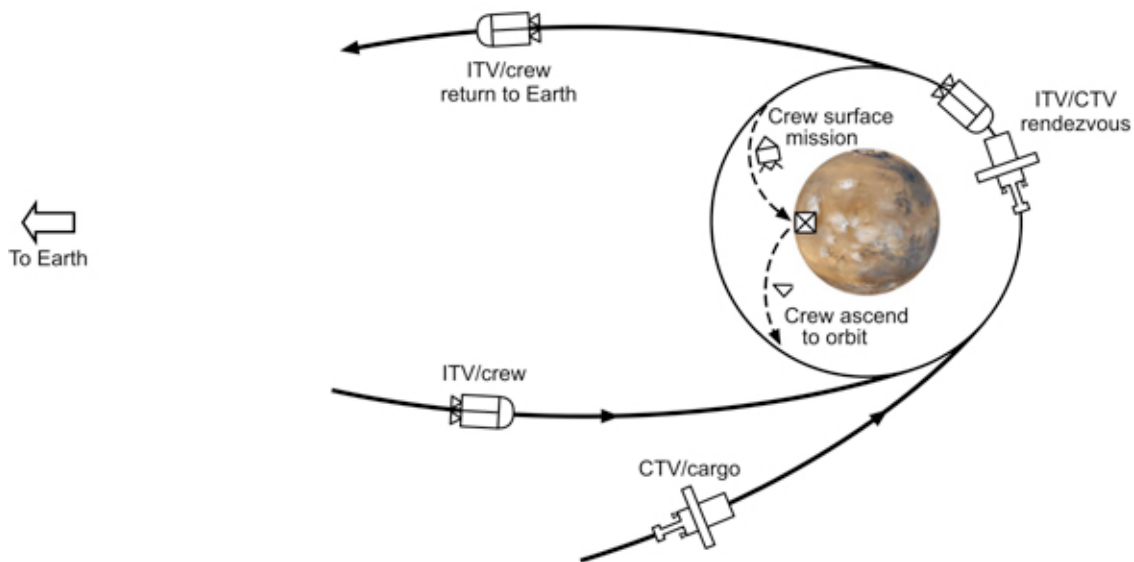

Mars mission schematic. The ITV and crew will rendezvous in Mars orbit with cargo sent previously, and use it to conduct their mission on the Martian surface. The robotic outpost emplaced earlier will be the hub of exploration activity and will provide immediate shelter and resources for the crew. The crew will ascend to Mars orbit following their surface mission, and will depart in the ITV for return to Earth in the usual manner. The CTV may be left in Mars orbit as an asset for the next crew, or it may also be returned to Earth for re-use.

Pre-emplaced factories will provide consumables, probably including oxygen and water, as well as propellant for the Mars ascent. These factories would have been established in Step 3 and their operation verified prior to the decision to proceed with the Mars surface mission. Power will be provided by a pre-emplaced fission power system or by networks of radioisotope power systems augmented by solar arrays and batteries.

Upon completion of their surface mission, the crew will depart in a Mars ascent vehicle and rendezvous with the ITV in Mars orbit. The ascent vehicle may be a re-use of the descent vehicle, or it may be a separate pre-emplaced vehicle. The ITV will return to Earth with the crew re-entering in a capsule, as in the previous steps.

Capabilities and Infrastructure

Having completed exploration Steps 1, 2, and 3 prior to the first mission to the surface of Mars, a large suite of very capable hardware elements will have been developed. These will have been progressively evolved through each destination, so that by Step 4 the common elements should have the required capabilities. There will, however, be a large number of unique elements that are required for the Mars surface mission. Some of these will be pre-emplaced during the Step 3 Phobos/Deimos mission, and others will be sent ahead as cargo. Some of the most obvious developments that will be required specifically for the Mars surface mission are:

- Mars descent and ascent vehicle
- Mars surface habitat
- *In situ* resource and propellant factories
- Mobility systems for Mars surface
- Scientific experiments, possibly including deep drills

Mars Descent and Ascent Vehicle

Soft landing on any planetary body with a sizeable gravity field (>0.01 of Earth's gravity) requires substantial engine thrust. For landed missions on large airless bodies such as the Moon, only a propulsion system and possibly some type of impact attenuation are required. At Mars we can take advantage of atmospheric drag and use an entry heatshield and parachute to obtain a large passive velocity reduction. The Martian atmospheric density is such that a heatshield/parachute is of significant benefit but is not sufficient to enable a safe touchdown, so sophisticated terminal propulsion is also required. Landing on Mars is the most demanding of all contemplated human solar system exploration objectives.

Orbital Waystations

As human presence in the solar system gradually becomes more permanent, it may be decided to emplace long-lifetime facilities at destinations that will be visited multiple times. This will minimize the amount of mass that must be carried on each individual mission. Waystations are habitats that could be pre-positioned by cargo flights at strategic locations in space. They would serve as intermediate staging locations with which any crew traveling to or passing through that destination could rendezvous, possibly to re-supply or to await the arrival of other crew or equipment.

Logical locations for waystations might include SEL2, lunar orbit, and Mars orbit. At Mars, a waystation could serve as the primary living quarters, thereby simplifying and lowering the mass (and thus the flight time) of the ITV. The waystation could also serve as a staging point for excursions to the surface, a command post for ground operations, and a safe laboratory facility for analysis of any potentially hazardous surface samples. The decision to develop and deploy waystations will most likely be made after the human exploration program has made substantial progress and the global community is firmly committed to its expansion.

A highly efficient design for the Mars Descent/Ascent Vehicle (MDAV) is critical, since every kilogram of Mars landed mass can require up to 40 kg of initial mass in low Earth orbit. In keeping with our architectural philosophy of emphasizing the use of proven systems, no new propulsion technology is required for the MDAV. By sending the MDAV as cargo and relying on the (by then) significant capabilities for astronaut servicing in orbit, highly reliable and reusable chemical propulsion systems will provide sufficient mass performance. A significant engineering design, development, and test program will of course be required during the years prior to the first human Mars mission, which should benefit greatly from the ongoing program of robotic Mars exploration and outpost deployment.

In this scenario a single vehicle (the MDAV) provides both the descent and ascent functions, but clearly there are options for pre-emplacement of a separate ascent vehicle on the surface as a part of the robotic outpost. In either case, it is possible that propellant for the ascent back to Mars orbit will be produced on Mars using Martian resources. Numerous concepts have been developed for such ISPP (*in situ* propellant production) factories, and their benefit in terms of reduction of launched and landed mass is well documented. After pre-emplacement during Step 3, production of a sufficient quantity of usable propellant could be verified prior to astronaut descent to the surface and possibly even prior to their departure from Earth.

The MDAV need not necessarily accommodate long-term occupancy, and thus its overall design can be quite spartan. The actual descent and ascent phases are very brief, so designing the MDAV for habitation for just a few days would take care of most orbital and surface rendezvous scenarios. This eliminates the need for high-technology life support systems or radiation shielding.

Surface Habitats

Surface facilities on a planetary body will serve primarily as shelter, isolating the astronauts from the hazardous external environment. This will include the usual controls on temperature, humidity, composition (CO₂, O₂, contaminants) and pressure similar to those needed onboard the ITV or other vehicles. For long-term operation in remote locations, these systems must recycle or regenerate their materials. Surface operations invoke the additional need for constant filtration of dust brought in through airlocks. Martian soil is extremely fine-grained, potentially causing silicosis-like pulmonary disease and causing wear and tear on mechanisms. Methods for rejuvenation of filters may be necessary for long-term operations.

To enable meaningful exploration it is essential that habitats also provide for laboratory work, such as sample analysis, and for the testing and repair of assets such as resource utilization factories. Not all research equipment brought to the surface will turn out to be equally useful or necessary, because exploration is a voyage into the unknown. Flexibility to adapt to new findings is critical, requiring a range of general-purpose items, such as microscopes and sample preparation equipment, as well as a suite of instruments whose purposes are highly specific and specialized, ranging from organic chemical probes to geophysical testers. If biological activity is suspected, the laboratory would have to be equipped with bio-isolation capabilities such as glove boxes or remote manipulators to protect the astronauts against organisms that might conceivably

be harmful, however unlikely that may be. Surface facilities must also accommodate hardware that will be needed for external exploration – rovers, drill rigs, robot assistants, emergency life support, resource-utilization equipment, and so forth. Repairs of internal habitat systems or parts taken inside the habitat from external equipment will require a small machine shop and electronics repair station.

Since accidents and unexpected events must be anticipated during a long-duration stay on an alien terrain under unfamiliar gravitational conditions, medical instruments and an area for diagnosis, treatment, and recuperation must be available. The capability to transmit detailed diagnostic information to Earth, and possibly for Earth-based physicians to program and remotely execute medical tests, will probably be required. Crew health and comfort must also be a primary design parameter. Exercise and recreational equipment will be essential for maintaining physical and mental fitness, and each crew member will need some private space for sleeping and relaxing. Facilities may also be allocated for features such as hydroponic gardens that may help to maintain some cultural connection to Earth.

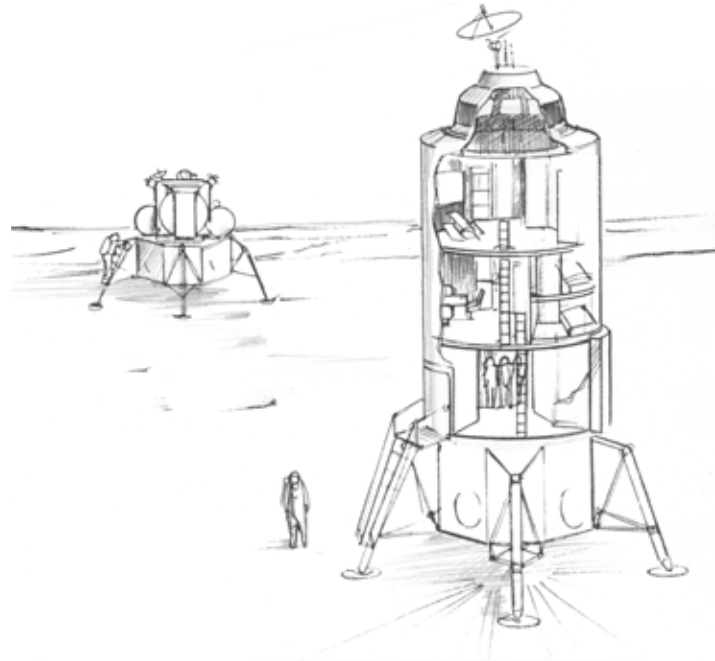

A Mars habitat and ascent vehicle may be pre-emplaced as part of a robotic outpost.

Not only must the surface habitat satisfy these internal design features, but its external shape and mass properties must be compatible with landing constraints. This can become a dominating configuration factor since these vehicles must incorporate a heat shield to survive atmospheric entry. On-site robotic assembly of separately landed elements can alleviate some of these concerns, but adds its own design complexities. All of these widely disparate requirements converge in what is likely to be one of the most difficult design and engineering challenge of the entire mission. Yet, most studies have so far placed much more emphasis on the definition and development of advanced transportation systems and space instruments than on the facilities that human explorers will need on other worlds. Preliminary requirements analyses and design studies of surface habitats should begin in the near term so that they can evolve as the engineering and transportation infrastructure develops. Early ground simulations under realistic conditions will reveal the shortcomings of theoretical designs and enable systems to avoid pitfalls that might greatly reduce the effectiveness of the critical first human missions.

Mobility

Human exploration of a wide variety of sites on Mars, potentially widely separated from the outpost location, is a key element of true exploration and scientific investigation of the planet.

The recent missions of the Mars Exploration Rovers at two strikingly different sites have highlighted the value of mobility for surface exploration. On the Martian surface, human geologists will benefit from a well-engineered rover that can enable sorties to distant field exploration sites and allow them to transport equipment within the outpost. This is not a trivial capability: terrain can be hazardous, supplies are very limited, walk-back is out of the question beyond distances of 10 km or so, and the crew will be somewhat exposed to excess solar radiation (although the Martian atmosphere does provide adequate shielding against all but the most highly energetic events). The rover would be pre-emplaced as a part of the robotic outpost and could even be operated robotically prior to arrival of the astronauts.

The ideal human mobility system would be pressurized, although it is possible that the first generation will be at ambient pressure and astronauts would rely on individual spacesuits for life support. It must have the capability to visit different types of Martian environments and acquire a large number of representative specimens for analysis back at the surface habitat. It should also include sophisticated tools and instrumentation for performing *in situ* investigations and selecting samples without requiring the astronauts to leave the rover. Through consultations with their counterpart scientists on Earth, rapid advances in understanding Martian surface processes should be possible. Compared with robotic exploration carried out from Earth, the leverage factor in time alone could be enormous.

In situ resource and propellant factories

Since even the first human stay on the Martian surface may last up to a year or more, local production of as many consumables as possible will be a critical capability. Launching all of the required water, oxygen, and propellant directly from Earth may be prohibitive, even considering the benefits of pre-emplacement and separate cargo flights. Overall mission efficiency can be greatly increased by taking advantage of the resources that already exist on Mars.

Technologies for production of water, oxygen, and rocket propellant have already been proposed and tested on Earth using Mars analog materials. Investments in these technologies over the coming decades should be directed at ensuring adequate performance and reliability for the first human Mars mission. Highly compact, efficient automatic factories should be developed and tested on the Martian surface via robotic missions, and when performance is sufficient they can be planned for emplacement at the developing robotic outpost. The ongoing robotic Mars exploration program is already dedicated, in part, to providing knowledge of the existence and accessibility of potential resources, especially water, and future mission objectives may be developed to refine that knowledge as the era of human Mars exploration draws near.

Role of Robotic Missions

Exploration of Mars is a joint robotic-human endeavor. Robotic missions will help to frame the objectives of human explorers and will characterize the environment and emplace assets to make human exploration safe and productive. NASA initiated its robotic Mars Exploration Program with the Mars Pathfinder and Mars Global Surveyor missions in 1996 and has launched missions to Mars at every opportunity since then. Europe has joined the Mars exploration community with Mars Express; in 2004 the missions operating at Mars include Mars Global Surveyor, Mars Odyssey, Mars Express, and the two Spirit and Opportunity rovers. NASA plans include a

reconnaissance orbiter in 2005, a polar lander in 2007, and a mobile science laboratory along with a communications orbiter in 2009. The ESA Aurora program (recently renamed the ESA Exploration Programme) begins in 2009 with a rover, and with a sample return mission to follow. As these programs evolve, they will play an increasingly important role in laying the groundwork for human Mars exploration. Some of the important objectives that may be achieved include, in roughly chronological order

- Complete the high definition imaging and compositional and topographical mapping of the planet from orbit.
- Emplace a network of real-time weather, navigation, and video-rate communications relay satellites (Mars-Mars and Mars-Earth) about the planet.
- Emplace a set of stationary seismic stations and weather stations in strategic locations around the planet. Conduct active seismic experiments to determine the internal structure of the planet, and release small, instrumented balloons for atmospheric sounding and dynamics.
- Conduct mobile robotic scientific expeditions at locales on the surface that promise increased understanding of the planet's geological, climatological, hydrological and biological history. These expeditions should include drilling and sounding experiments to search for subsurface ice, water, biology, and potential resources.
- Return to Earth a suite of carefully selected and well documented samples from several representative sites around the planet for scientific investigation. These samples will provide "ground-truth" reference points for interpreting *in situ* data and for improving instrumentation.
- Determine the hazards for humans including radiation and soil toxicity, and develop methods for their mitigation.
- Determine the feasibility for *in situ* resource production for both robotic and human explorers including construction materials, fuel, water, power and other consumables including food.
- Select the site for the first human expeditions and set up a robotic outpost with mobile exploration elements. This outpost should operate for several years, thoroughly characterizing and preparing the site before any commitment to send humans.

Summary: Architecture Step 4

The fourth and final step in this exploration architecture will result in the realization of a dream that has fascinated humankind for over a century. By following a series of logical steps in a well-conceived, evolutionary program of solar system exploration, humans will finally travel to the surface of Mars to live and work. In so doing they will open a new frontier and establish a permanent human presence on the most Earth-like planet in the solar system.

Even with the substantial developments that preceded it, the step to the surface of Mars will be the most challenging of the entire architecture. A large number of unique new capabilities will be required, including the Mars Descent/Ascent Vehicle (MDAV), surface habitats, mobility systems, *in situ* resource utilization factories, power and



telecommunications systems, and scientific tools. Much of the required material will be pre-emplaced on Mars in a robotic outpost that will thoroughly characterize the selected site and begin to process local resources well in advance of human arrival. A large NEP cargo vehicle will also precede the crew, carrying other equipment such as the MDAV, consumables, and perhaps propellant for the ITV's return trip to Earth. Safe arrival of the cargo vehicle will be confirmed prior to the crew's departure from Earth.

Robotic missions will play an important role in defining the activities of human explorers, characterizing the Martian environment, and emplacing assets on the surface. The ongoing international program of robotic Mars exploration has made tremendous progress in the past few years, and is largely responsible for the increased interest in and hopes for human Mars exploration.

Integrated Technology Planning and Development

Human space exploration missions will require all of the capabilities of robotic missions—lightweight spacecraft subsystems, efficient propulsion and power, accurate deep space navigation, reliable communications, etc.—but with the added requirements for human life support and human access to planetary environments, all with extremely high reliability. Many years worth of technical trade studies, technology development, and testing and validation will be required to meet these needs. This architecture represents a gradual development of the capabilities and building blocks to enable human exploration of the solar system to proceed in a logical, evolutionary fashion. Some of the developments will represent fundamentally new technologies and some will be more a matter of continued engineering progress in demonstrated capabilities. A well-planned technical development program that applies new developments judiciously, and that anticipates the flow of capabilities from destination to destination, will be a key to long-term success and affordability.

It is beyond the scope of this study to identify specific technology solutions for the entire set of challenges the program will ultimately face. Rather, we will show how the architectural principles we have established can be applied to one of the major technology challenges, namely that of transportation of crew and cargo. Our goal is to establish a framework for near-term progress that may aid in the identification of options for more detailed technical analysis.

The Transportation Challenge

The principle of separating crew and cargo makes it possible to view the transportation challenge in a new way. One of the key stumbling blocks to human exploration has always been the need for efficient, safe, and affordable transportation over very large distances and long flight times. The mass that must be moved to a solar system destination will be large compared to that for a robotic mission, and thus most human exploration scenarios have called for new heavy-lift launch vehicles, advanced human-rated in-space propulsion systems, significant developments to mitigate the health risks imposed by long crew flight times, or some combination of all three. This raises the cost of the first step beyond LEO to a level that has proven unattainable. Instead, we should seek to reduce transportation costs by using proven propulsion technologies in the roles for which they are best suited, and by using existing launch vehicles or straightforward

extensions of current launch systems. Such a program will depend in the near term on the development of astronaut and robotic capabilities for in-space assembly and refueling, and in the longer term on the development of techniques for *in situ* propellant production. Both of these may be seen as logical steps toward a permanent and productive human presence in the solar system.

Chemical propulsion

Chemical propulsion has been used on all previous scientific planetary missions, and so it offers the huge advantage of decades of refinement and flight experience. It provides a relatively high thrust level, which helps to keep flight times low; it can be started and stopped numerous times during a mission; and it has a long lifetime in deep space. Its reliability, flexibility, technical readiness, and affordability make chemical propulsion the best choice for crew transportation.

Existing chemical propulsion is adequate for the initial stages of this architecture that depend on the Geospace Exploration Vehicle for crew transportation (Step 1 to SEL2 and/or the Moon). Since the GEV is reusable, it will be designed for in-space refueling or for attachment of new propulsion modules ferried into space as cargo. At the same time, technology developments should be initiated focusing on maximizing efficiency, safety, and reliability, and on reducing the mass of chemical propulsion systems. The Interplanetary Transfer Vehicle that transports crew to NEO's and Mars will set the requirements for this enhanced chemical propulsion technology, but this technology will be of benefit to many robotic planetary missions as well. Such advances in chemical propulsion will keep interplanetary crew flight times as low as possible, and will help to determine the magnitude of developments required in areas such as life support systems and artificial gravity. Highly efficient chemical propulsion will also be needed for Mars ascent and descent, and so technology investments in this area are of very high leverage.

Electric Propulsion.

There are several types of electric propulsion (EP), but for our purposes the class also known as ion propulsion is of greatest interest. Ion propulsion systems use an electrically charged grid to accelerate ions of a propellant (xenon, for example) to very high velocities. Although the thrust produced is very low, when acting over long periods of time in the vacuum of space this technique can provide a large ΔV for a small amount of propellant. While the mass advantages of electric propulsion can be enormous, the downside for human exploration is the low thrust level of these systems. This means that for the destinations of interest to us, flight times may be long compared to chemical propulsion. EP systems do not provide sufficient thrust for rapid departures from LEO or capture into Mars orbit; rather, they must gradually spiral into or out of planetary orbit. They are also not useful for de-orbit prior to descent to the Martian surface, nor for the terminal braking required for soft landing.

By separating the crew and cargo transportation tasks, however, we can take advantage of the tremendous gain in efficiency made possible by this technology. Electric propulsion cargo vehicles will be sent to planetary destinations ahead of the faster, chemically-propelled crew vehicles so that they arrive either simultaneously or, more likely, so that the cargo arrives well in advance of the crew. The crew will then rendezvous with the cargo vehicle at the destination and

make use of the material it has brought. This cargo may be not just exploration equipment and robotic factories, it could include chemical propellant for the crew's descent to the Martian surface and possibly even for their return trip to Earth. In this way we can use the mass efficiency of electric propulsion to enhance the utility of chemical propulsion systems for crew transportation.

Electric propulsion systems can utilize either solar or nuclear power. Solar electric propulsion (SEP) has been under development for decades and has been demonstrated in space by the Deep Space 1, SMART, and Hayabusa missions. Its first use on a primarily scientific mission will be on the upcoming Dawn asteroid rendezvous mission in 2006, and it will almost certainly be used on other robotic planetary missions in the coming years. SEP can be used for missions to Mars and slightly beyond, but its effectiveness diminishes with increasing solar distance and it requires large solar arrays to achieve higher power levels, with a practical limit of about 50 kW.

Nuclear electric propulsion (NEP) depends on a fission reactor power source and is under development now within NASA's Project Prometheus. It is expected that power levels of 100–500 kW will be readily achievable in the next two decades, with extensions into the megawatt class as the technology matures. NEP can make possible a very large cargo transportation capability of tremendous benefit to a long-term program of human space exploration. The presence of fission power sources in Mars orbit and ultimately on the surface can also greatly enhance crew safety and productivity.

Electric propulsion and fission power represent two of the most important capabilities for a permanent human presence in space. They will allow us to off-load much of the high-mass equipment and infrastructure onto cargo vehicles, so that the crew can travel using minimum flight time trajectories and highly reliable, proven propulsion technologies. Extensive astronaut and robotic capabilities for rendezvous and in-space assembly and refueling are once again a key to making the best use of the propulsion tools we will have available. These technologies will be required for the missions to the Martian system in Step 3 and Step 4 of this architecture, and they may be important for the Step 2 missions to NEO's. Investments in these technologies should be accelerated so that they are ready and fully tested when the human exploration program is ready to take those steps.

Aeroassist

Atmospheric drag can be used very effectively to modify the orbit of a spacecraft, at a greatly reduced cost in propellant. There are two primary forms of this technique, one of which has already been utilized on robotic missions and one of which has been studied extensively but not yet put into practice. Aerobraking, which has been used at Venus and Mars, involves a propulsive orbit insertion burn followed by repeated passes through the upper part of a planet's atmosphere to gradually reduce orbital energy. Over time this can bring a spacecraft from a highly elliptical orbit to a low circular orbit, while using only a small fraction of the propellant that would be required to make the same change propulsively. In aerocapture, a spacecraft on approach to a planet makes a high-speed entry into the planet's atmosphere. This encounter is targeted to remove sufficient energy from the spacecraft's trajectory so that it is captured into orbit with no engine burn required. (A propulsive maneuver is required at the next apoapsis to

raise periapsis out of the atmosphere). For some missions, this can result in very large savings in propellant mass without the many orbits required for aerobraking. In both aerobraking and aerocapture the spacecraft must still carry a propulsion system for orbital adjustments and to ensure that subsequent periapses are at safe altitudes. Aerocapture requires a heat shield and thus a compact spacecraft design, which can negate some of the propellant mass savings, while aerobraking can be done gradually enough that a heat shield is not required.

In this architecture, we propose to make extensive use of aerobraking during return to Earth, and probably upon arrival at Mars, as a weight-saving measure. Both the Geospace Exploration Vehicle and the Interplanetary Transfer Vehicle should be designed from the outset with aerobraking in mind. The GEV will robotically aerobrake back into LEO upon return from the Moon or SEL2, after the crew has descended to Earth in the Crew Return Capsule. This avoids the penalty in crew flight time due to the numerous orbits required for aerobraking, and also allows the crew to avoid repeated passes through belts of high radiation. The ITV will most likely utilize aerobraking upon arrival at Mars, although a trade study must determine if the mass saved is worth the added flight time in Mars orbit (and thus relatively less time on the surface). The ITV is not likely to utilize aerobraking upon return to Earth, since the intent is to transfer it back to SEL2 for re-use. If it were decided for any reason to bring the ITV back to LEO, then aerobraking at Earth would certainly be considered.

Aerocapture is an undeveloped technology that raises significant crew safety issues and vehicle design constraints. In addition, in order to derive the benefits of aerocapture a mission would essentially have to be completely reliant on its success, which is probably not realistic for human missions, at least until aerocapture has been thoroughly developed and extensively used on robotic missions. For these reasons, we do not propose inclusion of an aerocapture capability for the ITV. If cargo missions to Mars were flown using chemical rather than electric propulsion, aerocapture could be an important means of increasing mass delivery. However, the benefits of electric propulsion for cargo delivery are so compelling that it is clearly preferred over chemical/aerocapture. Robotic science missions to more distant destinations, such as Titan or Neptune, may be enabled by aerocapture; as the technology develops, additional trade studies should be conducted to determine if there is a role for it in the evolving human exploration architecture.

In Situ Propellant Production

The use of extraterrestrial resources has often been proposed as a means to provide fuels, oxidants, and/or propellants for travel in the solar system. Such approaches offer an attractive alternative to lifting resources from Earth and carrying them along for the round trip. In most cases, of course, it remains uncertain whether the required resources actually exist in forms and amounts that would make their utilization cost effective. Such approaches would undoubtedly first be utilized on robotic missions, to demonstrate and validate the technologies and techniques and thereby reduce the risks to human explorers. While the emphasis here is on propulsion, it should be noted that an approach for obtaining and utilizing certain extraterrestrial resources, especially water, would have concomitant fundamental benefits in the area of life support for human missions.

Earth's Neighborhood. We know that oxygen is abundant on the Moon. The Lunar Prospector mission also revealed substantial amounts of hydrogen near the lunar poles, possibly in the form of water. Hydrogen and oxygen together are, of course, tremendously useful. Cryogenic O₂ and H₂ can be used to provide the highest-performance chemical bi-propellant systems feasible for human missions. The determination of the amount, accessibility, and usability of water on the Moon is an important robotic precursor goal for the early stages of this architecture.

Lunar resources could potentially be used to fuel spacecraft for their ascent from the Moon and return to Earth, but they could also be used for trips to other destinations. Energetically speaking, the lunar surface is actually closer to low Earth orbit than is Earth's surface. Thus, fueling spacecraft with lunar-derived propellants may be attractive. The use of lunar propellants could be particularly beneficial for interplanetary missions departing from an Earth-Moon libration point or a highly elliptical Earth orbit. The use of lunar-derived propellants and should be studied in detail as a means of reducing the Earth launch mass of human and cargo missions to asteroids and Mars.

Mars. Many investigators have speculated on the degree to which Martian resources may be valuable to support human exploration, both for life support and propulsion. For example, oxygen produced from Martian atmospheric CO₂ has been suggested for use in conjunction with hydrogen brought from Earth (or possibly methane for ease of storage) for ascent from the Martian surface to Mars orbit, and possibly for the trip back to Earth. Martian water could also be used to provide not only oxidant but also fuel for travel from Mars. For a long-term, sustainable program of human exploration, we believe the use of Martian resources to be a critical capability for which research and development should be accelerated. Safe and effective use of these resources would depend on pre-emplacment of a propellant factory whose operation could be verified prior to the arrival of human explorers. As is always the case, the feasibility and cost-effectiveness of such scenarios depend on the existence, abundance, and



accessibility of the resources in question, and early robotic missions should be targeted at answering these questions and on demonstrating key technologies. Moreover, the additional life support benefits associated with some extraterrestrial resources—H₂O in particular—mean that we probably should not assess the benefits of such techniques from the standpoint of propulsion only, but rather from a total mission perspective.

Near-Earth Asteroids. Near-Earth asteroids might prove to offer a number of advantages over the Moon for resource utilization. Although more distant, their low gravity reduces the ΔV for repeated landings and lift-offs, and SEP could be used to advantage to ferry raw materials back to Earth's vicinity. The water content and abundance of asteroid materials is thought by some to be much more significant than that of lunar material, offering the potential for more efficient production of H₂, O₂ and hydrocarbon fuels. They are also rich in a number of pure metals (Al,

Ni, Co, Ca, Fe, etc.) of potential interest for other uses in space or on Earth. Early robotic missions should identify resources and assess their utility, and this may affect architectural decisions on whether and how NEO's should be included in the overall exploration program.

Summary: Transportation Challenge and Solutions

Safe and cost-effective transportation of crew and all their required equipment and resources throughout the solar system is arguably the greatest barrier to a long-term, sustainable program of human exploration. While many futuristic and elegant propulsion technologies have been proposed to address this problem, their high cost and speculative nature has proven to be a hindrance to actually beginning human exploration beyond LEO. In keeping with the stepping-stone philosophy, this architecture addresses the problem by separating crew and cargo and emphasizing the use of a combination of capabilities:

- *Chemical propulsion*: Enables safe and reliable crew transportation to and from destinations. Technology is mature and current performance is adequate for initial steps. Performance improvements can significantly enhance missions to NEO's and Mars. Also needed for Mars ascent/descent.
- *Electric propulsion*: Enables highly efficient cargo transportation to Mars and to NEO's (if required). NEP is preferred due to higher power levels, but SEP may be utilized in near term.
- *Aerobraking*: Multiple atmospheric passes following propulsive orbit insertion enables fuel mass reduction for return of the GEV into LEO and for placing the ITV into a low Mars orbit. Implemented robotically on the GEV; crew descends to Earth surface prior to aerobraking.
- *In-space assembly and fueling*: Greatly enhances capability of crew vehicles by breaking mission into segments and allowing astronauts to refuel using robotically delivered propellants.
- *In situ propellant production*: Makes use of propellant derived at the destination for ascent and return to Earth. May also use propellant derived from lunar or NEO resources to enable trips to Mars.

By developing this suite of capabilities, we can build a transportation infrastructure that will enable long-term human exploration of the solar system and efficient access to a wide variety of destinations.

Trade Studies

The study on which this report is based is conceptual in nature, and does not attempt to conduct detailed technical analyses. Our hope is that by establishing some general architectural principles and exploring their implications, we can identify important attributes that can help to make human exploration of the solar system a reality. In the process we have identified a number of trade studies that will allow key engineering and programmatic decisions to be made. These are summarized below for each destination, with the recognition that this is not an exhaustive list. In each case, the trade study should be conducted under the assumption that human exploration beyond LEO is a given, and that eventual human presence on Mars is the

long-term goal. These trade studies are not intended to determine *whether* humans will explore the solar system, but only *how* they should proceed at each destination.

Sun-Earth L2

- Examine the various configurations for large aperture, long baseline space telescopes and interferometers for study of the deep universe and for the detection, spectroscopic study, and imaging of extra-solar planets.
- Compare the utility of robotic vs. human construction and servicing of space telescopes located at SEL2, as a function of size and complexity. Considerations include construction and servicing architecture, single vs. distributed aperture, aperture complexity (deployable, segmented or monolithic), supported vs. gossamer apertures, launch environment, and instrument complexity and servicing difficulty.
- Compare the cost, lifetime, and performance of space telescopes and constellations assembled and serviced on-station at SEL2, vs. assembly/servicing in a highly elliptical Earth orbit with robotic transfer to/from SEL2.

Moon

- Determine the relative value of robots vs. humans for key scientific investigations. In particular, under what circumstances can lunar robots with human operators on Earth accomplish complex field work, including identification of stratigraphy, sample selection, and context characterization; and conversely, under what circumstances are human lunar field geologists better?

- Compare robotic vs. human capabilities for emplacement of delicate surface instruments, precision alignment, and operation and servicing of complex surface instruments.

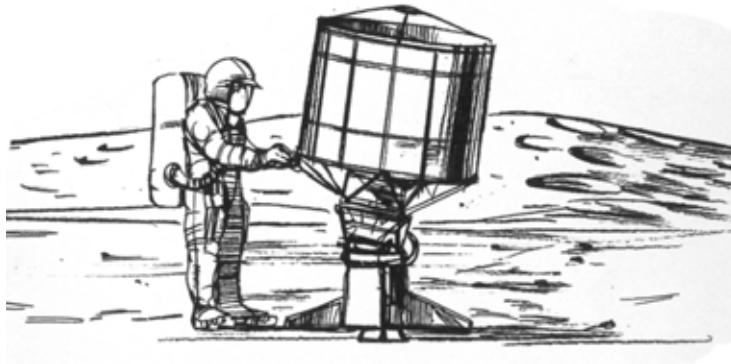

- Assess progress in developing compact instruments, suitable for robotic missions, for *in situ* radiometric age dating of lunar surface samples.
- Assess the prospects and methodologies for finding meteorites from Earth, Mars, and Venus on the Moon, and for

determining the history of impacts in the inner solar system.

- Determine what types of astronomical facilities, other than a far-side radio telescope, would be better served by emplacement on the Moon rather than as free flyers at SEL2.
- Determine the value of lunar polar H₂O deposits, should they exist in useable form, for resource production on the Moon. Do these resources have any practical application for utilization in interplanetary transportation?
- Study the relative value of the Moon vs. locations on Earth as a training ground for future Mars expeditions and as a technology testbed.

Near-Earth Objects

- Develop scenarios for mitigation of an Earth impact threat, and assess the viability of robotic vs. human missions to complete the required missions.
- Compare robotic and human explorers in terms of their ability to determine the physical characteristics of an NEO, in a cost-effective manner, to the degree necessary to support impact mitigation studies.
- Determine the ability of robotic missions, and any necessity for human missions, to exploit NEO's for resources to be exported to Earth or utilized in space.

Mars

- Compare robotic and human capabilities to determine the extent to which robotic systems can explore the planet, what limitations are likely to restrain robotic exploration, and for which specific scientific objectives human explorers will clearly be required.
- Conduct an in-depth examination of the robotic-human interface to determine how robots can best be used to amplify human capabilities for exploration of the planet.
- Study the benefits of *in situ* resource production vs. transport of consumables from Earth, assuming the presence of a large NEP-based cargo transport system. Determine which specific resources are best suited for *in situ* production.
- Study the potential for developing an instrumented lab on Mars outpost that duplicates to the maximum extent possible the analytical and age-dating measurements that can be done in Earth laboratories.
- Determine the efficacy of enclosures on Mars for self-sustaining human environments, and assess the cost-effectiveness of growing food plants in such enclosures in comparison with the transportation of all food from Earth.
- Study the utility of Phobos and Deimos as logistical nodes in human Mars exploration.
- Conduct a study on the various means of preventing human contamination of any potential Mars biosphere, including back contamination of Earth by returning humans.
- Determine the long-term programmatic benefits of implementing artificial gravity and accepting longer crew flight times, vs. minimizing flight time and applying more modest capabilities to mitigate the effects of zero gravity.
- Study the medical aspects of humans on Mars including radiation, dust toxicity, and low gravity, and determine the preferred relative mix of time in Mars orbit vs. time on the surface.
- Determine the importance of a functioning Mars robotic outpost as a precursor to human exploration, and define the optimum content and configuration of such an outpost.

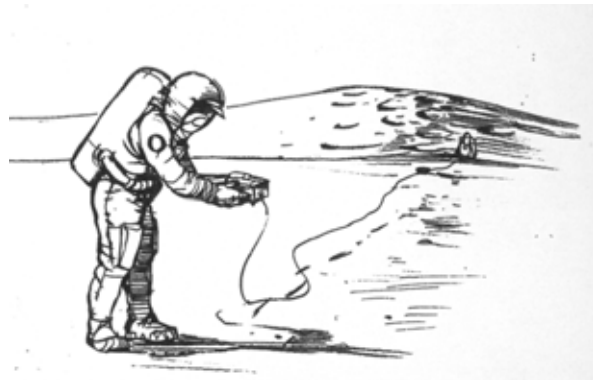

Engaging the Global Community: Policy and International Cooperation Considerations

The future exploration of space will have worldwide significance and impact. All across planet Earth countries and peoples share an interest in future space exploration missions. The first human-carrying mission of Vostok 1 and the Apollo Moon landings demonstrated this.



This study assumes that exploration of space is intrinsically a global enterprise.

This study recognizes that several space-faring countries are developing their own space exploration “visions” as well as “roadmaps” to achieve their goals. While the visions and roadmaps may differ and while some countries may prefer not to depend on others for success, this study assumes that there will be numerous opportunities to coordinate activities and to cooperate in the achievement of long-term exploration goals.

In addressing the policy and international aspects of space exploration, one should consider the prerequisites and challenges associated with human exploration missions, the potential participants in future missions, the prospects for private sector participation, potential cooperation approaches, and lessons learned that may apply to future initiatives.

Prerequisites

In order for a group of space-faring countries to consider embarking on a deep space exploration mission, they will need to anticipate over a lengthy period sufficiently *positive economic conditions* to support the long term funding requirements of a deep space exploration program. Countries experiencing economic difficulties may be reluctant to participate in new initiatives that utilize scarce resources for “discretionary” purposes. On the other hand, some countries may decide to invest in exploration initiatives, even though available resources are limited, to stimulate their scientific, technological and industrial infrastructure, and to inspire young people to pursue careers in scientific, technical and exploration-related fields.

Stable, mutually satisfactory political relationships that endure for many years will also be needed. This does not mean that peace and harmony must exist in all countries throughout the world. Indeed, international competition can provide an impetus for an exploration initiative, as it did when Spain sponsored the voyage of Columbus and when the United States initiated the Apollo and International Space Station programs.

Challenges

In pursuing future space exploration missions, a number of challenges will need to be addressed. These challenges are likely to include:

- **Cost:** A long-term exploration program that culminates in sending humans to Mars will certainly require a substantial amount of money.

It is conceivable that one country could provide all or most of the required funding for a human mission to the Moon and/or to Mars as the United States did for the Apollo program during the 1960s. However, national funding realities in the United States, Europe, Japan, Russia and most other major space faring countries suggest that long-term robotic and human exploration will be difficult to sustain if funded by only one country. A more likely scenario involves several countries contributing varying amounts of funding and other resources to pursue their space exploration goals in a collaborative fashion. The participating countries would both coordinate national missions and, on a project-by-project basis, cooperate on space exploration missions. When pursued simultaneously these efforts offer the prospect of reducing the cost burden on individual participants while increasing robustness and enhancing the scientific and technological character of the overall undertaking.

In choosing to cooperate, prospective partners will want to assure each other that the cost estimates they develop for future exploration missions are carefully prepared, contain adequate margins for unforeseen challenges, and therefore are credible.

- **Sustainability:** The exploration of space is a long-term venture. Countries pursuing their space exploration visions will probably do so in a series of steps over a twenty to thirty year period. The individual steps are likely to be taken on a “go as you can pay” basis. As each step is completed the participant(s) will draw on the experience gained and incorporate it into planning for further steps.

Successful pursuit of national space exploration visions will require a clear overriding rationale that can be sustained as the individual steps are taken. Clearly visible, periodic accomplishments will be needed to maintain public interest and support. The need for periodic “milestones” – some of which may involve political, not technical, achievements – should be recognized at the outset and built into the long-term architecture.

In addition, sustainability of space exploration activities can be enhanced, and even secured, through international coordination and cooperation on space exploration projects and plans.

- **Risk:** In order to ensure sufficient long-term support for exploration missions, several types of risk need to be addressed.

The crew involved in long duration exploration missions, such as future missions to Mars, will face considerable risk that must be acceptable not only to the participants but also to the leaders and peoples of the participating countries.

There are also risks associated with the contamination of other celestial bodies with materials brought from Earth, and with the return of planetary materials (including life) that could contaminate our environment. International planetary protection guidelines have been established by COSPAR to address such risks, and are kept up-to-date with the latest scientific findings. The exploration partnership will need to follow those guidelines and also assure the global community that the measures being taken are adequate.

Countries conducting space exploration programs also risk failing to meet schedule and mission performance criteria toward which they have devoted significant resources and national prestige.

In cases where the risk is considered too high, efforts to reduce it can be undertaken. Such efforts will increase the overall cost of the exploration initiative, but not necessarily the actual run-out cost to achieve success.

While risk is a challenge that must be addressed, the presence of risk can also increase public interest in the drama of exploration. This has been recently illustrated by public interest in the Mars Exploration Rover missions, for which the risk associated with safe landing on Mars was well articulated. Attention must be paid, however, to public apprehension about the danger associated with the loss of human lives as the Shuttle Columbia accident once again illustrated.

- **Technology:** Significant investments in space technology and research will need to be made prior to the initiation of major space exploration missions. Space agencies in the United States and Europe have recently initiated programs to accelerate development of space propulsion, long duration life support, and advanced communications technologies for use in future exploration missions. Russia has also been working in these areas since the 1960s.

Some of the technologies that enable the pursuit of space exploration will present additional challenges for countries seeking to employ them in an international context. These challenges include constraints on the sharing of advanced technologies for military security and economic competitiveness reasons. Countries seeking to cooperate in space exploration may face a particularly difficult challenge when they seek to develop effective working relationships that respect national controls on the export of equipment and technical data.

The use of nuclear materials and technology for propulsion and power will also create policy and public relations challenges that will have to be overcome.

Potential Participants

Which countries might seek to pursue and cooperate on future robotic and human space exploration missions? Based on their current interests and plans, the candidates are likely to include Canada, China, Europe (including the European Space Agency and several of its member states with national program interests), India, Japan, Russia, and the United States.

Canada

Background: Canada participates in both the Space Shuttle program through the provision of the Canadarm1 remote manipulator system and the Space Station through provision of the Mobile Servicing System that includes the Canadarm2 and a Special Purpose Dexterous Manipulator (SPDM).

In 1999 the Canadian Space Agency (CSA) expanded its activities with the establishment of a Space Exploration Program to pursue Canadian scientific and technological participation in the robotic and human exploration programs being planned by NASA and ESA.

Interests: Canada has expressed strong interest in NASA's robotic Mars exploration program. Canadian scientists—supported by CSA—are participating in NASA's 2007 *Phoenix* Mars Scout mission. Canada is also participating in the study phase of ESA's Aurora space exploration program.

Canada's scientific interests in future exploration missions include planetary atmospheres and geology. Canada's life science program is also focusing on bone and muscle loss, cardiovascular and metabolic science, radiation, neuroscience and the isolation/multi-cultural psychology aspects of long duration human space missions.

Capabilities: Based on its robotic contributions to the Shuttle and Space Station programs and the evolution of these technologies, as well as its science and science-payloads expertise, and a small corps of astronauts Canada is positioned to play a role in future robotic and human exploration missions.

China

Background: In October 2003 China successfully launched the first Chinese *taikonaut* into space on the Shenzhou 5 mission. Shenzhou 5 followed four unmanned precursor missions that rehearsed virtually all technical aspects of human space flight. Further Shenzhou missions with *taikonauts* aboard are being planned by the China Aerospace Science and Technology Corporation (CASC), which is responsible for implementation of China's human space flight program called Project 921.

The first Chinese satellite (DFH-1) was launched in 1970. Since then, China has expanded its space activity into communications, meteorology, space science, oceanography, remote sensing, and navigation satellites. In addition to pursuing Project 921 China has also developed the Long March family of launchers including the Long March 2-F rocket that launched Shenzhou 5 from

the Jiquan launch site. Besides Jiquan, China has constructed launch sites at Xichang for geostationary satellites and at Taiyuan for polar missions.

The Shenzhou spacecraft is capable of carrying three *taikonauts*. It has a service module housing the propulsion system, a command module, and an orbital module with a docking ring and two sets of solar panels, enabling it to remain in orbit independently for prolonged periods. The Shenzhou orbital module could serve as a first step in the development of a Chinese space station.

Interests: During the past several years Chinese space officials have indicated that they are formulating plans to conduct a series of robotic missions to the Moon as part of a program called *Chang'e*. These missions are likely to include a lunar orbiter, a robotic lander, and a sample return mission. Chinese scientists have also expressed interest in human missions to the Moon and in robotic and human missions to Mars.

Capabilities: The Chinese space program has developed capabilities that could contribute to future robotic and human exploration initiatives. These capabilities might include:

- Provision of launcher capabilities (and associated launch sites) based on the Long March 2F launcher currently used to launch the Shenzhou missions. Chinese officials have also stated their intention to develop a heavy lift launcher capable of carrying a 25 metric ton payload to low Earth orbit.
- Orbital systems based on China's plans to develop a space station.
- Ground facilities for tracking and perhaps other support.
- A small but growing corps of Taikonauts.

Europe

Background: Europe has participated in the Space Shuttle and the Space Station programs on a regional basis through the European Space Agency (ESA). For the Space Station ESA is providing the Columbus Laboratory, the Automated Transfer Vehicle (ATV) and a variety of other smaller elements. ESA plans to launch the ATV on its first demonstration mission in 2005. The baseline Ariane-5/ATV configuration will be capable of carrying up to 9 metric tons of fuel and cargo to the Station.

ESA's original human space program plans—formulated in the mid-1980s—included the development of a space plane (Hermes, to be launched on a human-rated version of Ariane-5) and a man-tended free flier facility. ESA also anticipated eventual development of a small European space station. These plans were dropped in the early 1990s.

ESA plays a leading role in Europe on robotic exploration activities. In 1985 ESA launched the *Giotto* mission that flew close to Halley's Comet in March 1986. ESA developed the Huygens probe as part of the Cassini Huygens mission to Saturn that was launched in 1997 and inserted into orbit around Saturn in 2004. In 2003 ESA launched the *Mars Express* spacecraft that is now orbiting Mars. In 2003 ESA launched the *SMART-1* technology mission that is on its way to the Moon. In 2004 ESA also launched the Rosetta comet mission. In addition ESA is pursuing

robotic missions to Venus (*Venus Express*) and Mercury (*BepiColombo* that will be developed in cooperation with Japan).

Interests: If Europe participates in a future space exploration initiative, it is likely to do so through ESA. With this in mind in 2001 ESA's Member States established the Aurora space exploration program to plan future robotic and human exploration missions.

At the same time France, Germany, Italy and other European countries have national capabilities and interests that could result in additional opportunities for cooperation in preparing for and conducting future exploration programs.

The objective of Aurora – recently renamed the ESA Space Exploration Program – is to formulate and implement a long-term European plan for robotic and human exploration. In support of these activities, ESA and several of the ESA member states are conducting preliminary studies and are developing medium and long-term space exploration plans. The prospective robotic missions currently being studied by ESA include:

- An entry, descent and landing technology demonstration mission.
- A Mars exobiology mission called Exo-Mars.
- A Mars Sample Return mission.

In addition ESA and its member states are studying several human spaceflight initiatives including:

- Development of a Cargo Ascent and Return Vehicle derived from the Space Station Automated Transfer Vehicle
- Conduct of crewed Soyuz missions from Europe's Kourou Space Center.
- Development of new human space flight program capabilities including an international berthing and docking mechanism, inflatable space systems and an advanced regenerative life support system.

ESA's goal is to position Europe to play a "prominent role" in an international scenario of human exploration of the Moon and Mars "consistent with Europe's traditions and ambitions." While this could lead to one or more European-led exploration missions, most ESA and ESA member state officials assume that the major human exploration initiatives will be pursued in partnership with other countries.

In developing its space exploration program plans ESA is working closely with the European Union which recognized space exploration as a potential European initiative in a White Paper on

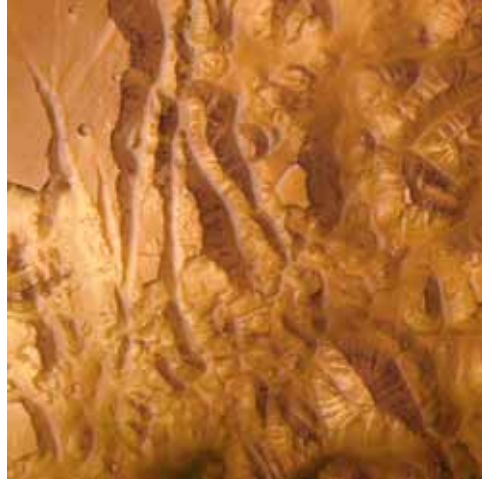

This high-resolution image of the Valles Marineris area on Mars was taken by the High Resolution Stereo Camera on ESA's Mars Express spacecraft in January 2004. (Courtesy ESA/DLR/FU Berlin)

space released in November 2003. ESA has also established a Space Exploration Policy Assessment Group which includes participation from the European Commission, ESA Member States, European science institutions and European industry. SEPAG is assessing current developments in other countries and has begun to elaborate a European strategy for space exploration.

Capabilities: Based on Europe's launcher, space science, Spacelab and Space Station experience, ESA and its member states could contribute to a future exploration initiative through:

- Provision of launcher capabilities (and associated launch sites) that carry and/or support future robotic and human missions. ESA's plans call for development an upgraded Ariane-5 launcher with new main stage engine (Vinci) and a re-startable cryogenic upper stage (ESC-B) that would be capable of launching the ATV with approximately ten tons of cargo to low Earth orbit. ESA and the Russian Federal Space Agency are also studying the possible use of Europe's Kourou launch site for future human-rated Soyuz missions.
- Development and operation of human rated space flight infrastructure elements, rendezvous and docking systems and inflatable structures.
- Development of robotic satellite systems and science payloads.
- Use of ground facilities including Europe's new deep space tracking station in Australia.
- A European astronaut corps and astronaut training facilities.

ESA's Member States have also decided to begin a Future Launcher Preparatory Program (FLPP) to develop new technologies for future European launch vehicles. FLPP will focus on developing reusable launcher technologies and could result in new capabilities of potential value to a future exploration initiative. In addition, under the Aurora program Europe is studying possible future technology investments in robotics, entry, descent and landing, alternative power generation and micro-avionics.

India

Background: While India has no current human space flight program plans, the Indian Space Research Organization (ISRO) has pursued development of expendable launch vehicles that could contribute to future exploration initiatives. ISRO's Polar Satellite Launch Vehicle (PSLV) is capable of carrying 3,700 kilograms to low Earth orbit. ISRO has also successfully launched its Geosynchronous Satellite Launch Vehicle (GSLV, capable of carrying a 2,000 kilogram satellite to GTO) in April 2001 and May 2003.

Interests: With regard to exploration beyond low Earth orbit, India's near-term attention is focused on the Moon. In October 2003 India's Prime Minister announced plans to launch the *Chandrayaan -1* lunar orbiter mission as early as 2008 using a modified version of the PSLV. *Chandrayaan -1* will collect imagery of the Moon's surface using high-resolution remote sensing instruments in the visible, near infrared, low and high-energy X-ray regions. ISRO is also studying a follow-on lunar mission with landed science capabilities as well as future robotic planetary missions.

Capabilities: Based on its current capabilities India could contribute to future exploration missions through the launch of equipment and supplies to low Earth orbit and possibly to the

various Lagrangian points and the Moon. India might also provide scientific instruments and terrestrial research facilities to support future exploration activities.

Japan

Background: In October 2003, the Japanese Government established a new national space and aeronautics, research and development organization called the Japan Aerospace Exploration Agency (JAXA) that merged the activities of the Institute of Space and Astronautical Science (ISAS), the National Aerospace Laboratory of Japan (NAL) and the National Space Development Agency of Japan (NASDA). Through NASDA, now JAXA, Japan has participated actively in the International Space Station program. JAXA is developing several major Space Station elements including the *Kibo* Japanese Experiment Module (JEM), a centrifuge rotor and Centrifuge Accommodation Module (CAM), and the H-2 Transfer Vehicle (HTV). The HTV will utilize JAXA's H-2A launch vehicle to transport equipment and supplies to the Space Station. The HTV is scheduled to make its first demonstration flight in 2007 and, using an augmented version of the H-2A launcher, will be capable of carrying approximately 6 tons of cargo to low Earth orbit.

Through ISAS, Japan has been very active in solar system exploration. In 1985 ISAS launched the *Sakigake* and *Suisei* missions to study Halley's Comet. In 1998 ISAS launched the *Nozomi* Mars mission which, due to an unrecoverable on-board malfunction, could not be inserted into Mars orbit as planned in December 2003. In May 2003 ISAS launched the *Hayabusa* asteroid sample return mission. These missions have been part of an overall ISAS effort to launch one small mission every year, and one larger, often cooperative mission every five years, to provide flight research opportunities.

Japan is also working on several reusable launch vehicle and advanced space transportation technology projects. Prior to the establishment of JAXA, NASDA and NAL had pursued development of an un-piloted H-II Orbiting Plane-Experimental (HOPE-X). In recent years NASDA and NAL scaled back their plans in favor of a High Speed Flight Demonstration (HSFD) project. HSFD is intended to validate autonomous approach and landing technologies and investigate the transonic aerodynamic characteristics of a winged re-entry vehicle.

Interests: Japan's near-term exploration interests have been focused on the Moon as the closest and most familiar celestial body and a logical first step for future exploration activities. Japan is currently pursuing two lunar missions:

- The *Lunar-A* scientific orbiter – which will also carry two instrumented penetrators – is scheduled for launch in 2004.
- The *Selene* science and engineering orbiter to study the Moon's origin and evolution and to develop technologies for future lunar exploitation. The first *Selene* is scheduled for launching in 2006 or 2007. JAXA envisions launching additional *Selene* missions that could include sample return capabilities.

JAXA is also studying a possible further robotic Mars mission in the 2014 time frame.

In the mid-1990s the Japanese Government elaborated a long-term vision that included development of a lunar base and participation in future international human space missions. The Government is currently discussing elaboration of a new vision.

Capabilities: Based on its launch vehicle, space science and Space Station experience, Japan could contribute to a future exploration initiative through:

- Provision of launcher capabilities (and associated launch sites) that carry and/or support future robotic and human missions. These capabilities could utilize and/or evolve from Japan's current M-V and H-2A launcher systems.
- Development and operation of human rated space flight infrastructure elements based on the *Kibo* Japanese Experiment Module and associated elements.
- Development of robotic satellite systems and science payloads. This includes rendezvous and docking capabilities such as those demonstrated during JAXA's ETS-7 mission and sample return capabilities to be demonstrated during the *Hayabusa* asteroid sample return mission.
- Ground systems including use of Japanese deep space tracking facilities.
- A Japanese astronaut corps.

Japan's reusable launch vehicle and space plane technology programs may also result in capabilities of potential value to future international exploration initiatives.

Russia

Background: The Soviet Union was the first country to launch a human into space, in 1961, and the first country to send a *cosmonaut* on an extravehicular activity ("spacewalk") in 1965. The Soviet Union was also the first to launch a space station, Salyut 1 in 1971, which was followed by several other Salyuts and, in 1986, the core of a new modular space station, Mir. Other modules were added to Mir in subsequent years. The Mir complex operated until 2001, when it was de-orbited. The Soviet Union also played a very active role in launching robotic missions to the Moon, Mars, Venus, and Halley's Comet.

Russia joined the International Space Station partnership in 1993 and has provided orbital infrastructure elements as well as logistical support to the program. Russian Soyuz and Progress vehicles have played a crucial role in maintaining crewed Station operations during the period following the loss of NASA's Space Shuttle Columbia in February 2003. Russia currently is the only country able to provide access to the Space Station for crew exchange/rescue and for cargo re-supply.

Interests: Russia is very interested in exploration—particularly in exploration of the Moon and Mars. These interests began in the 1960s when Rocket Systems Corporation "Energia" studied missions based on the H-1 Russian lunar rocket and have included a solar electric based design completed in the 1990s. More recently, some of the Russian interest in exploration has been documented in an International Science and Technology Center study on Mars Exploration (ISTC 1172) that was initiated in 1999 and completed in 2001. The ISTC—established by the United States and European Union in 1992—provides funding support for non-defense study projects undertaken by former Soviet Union scientists and engineers.

The “1172” Mars Exploration study project involved a number of Russian institutes and industrial organizations. It focused on the design of a future Mars human exploration mission. The results of the 1172 study were published in 2001 and provided the impetus for a follow-on study—ISTC 2120, which is now underway—to identify the “key technical means” for a future exploration mission.

In 2003 the Russian Aviation and Space Agency Rosaviakosmos – renamed the Russian Federal Space Agency (FKA) in 2004 – announced plans to develop the *Angara* heavy lift vehicle and to pursue concept studies on future reusable launch systems.

In addition, Russian institutes and industrial organizations are pursuing research and development in a number of exploration-related fields including solar power systems, nuclear power systems and inflatable structures.

Capabilities: With its long experience in human and robotic space flight, Russia has many capabilities that could become important in designing, developing and executing future exploration initiatives. These include:

- Launcher capabilities and associated launch sites based on the current Soyuz and Proton launch vehicles and new vehicles now in development.
- Crew transportation systems based on the Soyuz TM and a new crew vehicle – called Klipper – currently under study in Russia that could carry up to six crew members to the Space Station.
- Orbital systems capabilities and experience based on the development and operation of the Salyut and Mir stations.
- Development of robotic spacecraft for solar system exploration based on Russia’s historical expertise and on a current plan for a Phobos soil sample return mission in 2009.
- Use of ground training and human space mission operations facilities.
- Propulsion technology experience.
- Biomedical and long duration human space flight experience.
- Space nuclear power experience.
- A Cosmonaut corps and associated human space flight training facilities.

United States

Background: The United States is the only country that has sent humans beyond low Earth orbit. The United States has also sent robotic scientific spacecraft to the Moon, to Mars, to other planets in the solar system and beyond. The Apollo program focused on the landing of humans on the Moon with a safe return back to Earth by the end of the 1960s, a feat that was first accomplished in July 1969. The United States continued sending human crews to the Moon until 1972, launched the Skylab space outpost in 1973 and conducted the Apollo-Soyuz test project with the then Soviet Union in 1975. In 1981 NASA launched the first Space Shuttle (which involved the participation of Canada and Europe) and in 1984 the United States announced plans to construct a permanently crewed international space station. The International Space Station is being developed in partnership with Canada, Europe, Japan and Russia. Brazil and Italy are also cooperating with the United States on the Space Station program.

Interests: The United States has long been interested in exploration beyond low Earth orbit and has conducted a number of space exploration studies. The Report of the U.S. National Commission on Space in 1986 recommended that the United States “lead the exploration and development of the space frontier... from the highlands of the Moon to the plains of Mars.” Responding to a challenge issued by President Bush in 1989, NASA established the Space Exploration Initiative. NASA and the White House then commissioned several studies that led to recommendations on sending humans back to the Moon and then to Mars by 2019. These recommendations were not pursued.

The results of studies on life in extreme environments on Earth as well as the 1996 discovery of a Mars meteorite that appeared to contain indications of primitive life forms triggered renewed U.S. interest in the possibility of life on Mars. During the same period NASA initiated an aggressive program of robotic Mars exploration.

In 1999 NASA created the Decadal Planning Team (DPT)—later renamed the NASA Exploration Team (NEXT)—to elaborate future exploration technology requirements and goals for a future NASA exploration mission beyond low Earth orbit. The DPT/NEXT initiatives produced a number of studies on:

- Alternative scenarios, architectures, and mission concepts to achieve NASA’s exploration science goals.
- Technology roadmaps and establishing investment priorities.

The DPT/NEXT initiatives also resulted in the establishment in 2002 of a NASA Space Architect’s Office to conduct studies and coordinate investments into critical “building block” technologies.

In January 2004, President Bush announced that NASA would pursue a long-term space exploration initiative involving robotic and human missions to the Moon, to Mars and other destinations beyond low Earth orbit. President Bush called for a return of humans to the Moon no later than 2020. He directed NASA to restructure its current programs in order to focus on pursuing space exploration. The President invited other countries to help implement this long-term initiative.

Capabilities: The United States has a number of capabilities that can be applied to the planning, development and execution of missions to explore space beyond low Earth orbit. These capabilities include:

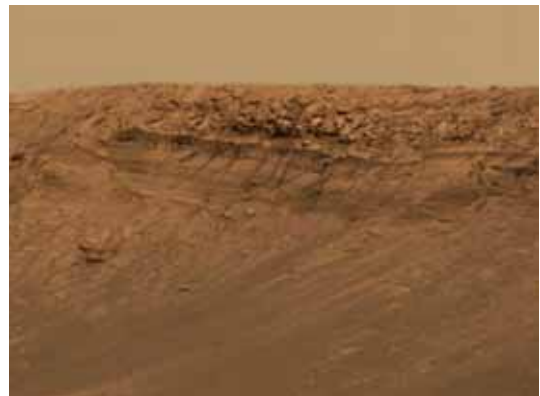

*This image was taken by NASA’s Mars Exploration Rover Opportunity as it approached the Endurance Crater on Mars in June 2004.
(Courtesy: NASA/JPL/Cornell)*

- Launcher systems and associated launch sites based on the Space Shuttle and on the Atlas 5 and Delta 4 expendable launchers.
- Orbital space systems capabilities and experience based on the development and operation of the NASA elements of the International Space Station
- Ground research, training and space mission operations facilities.
- Power and propulsion technology know-how including experience in developing and operating radioisotope thermoelectric generators and radioisotope heating units. NASA also has space nuclear propulsion experience and recently began development of a nuclear fission electric propulsion system.
- Biomedical and long duration human space flight experience.
- Robotic solar system exploration spacecraft as well as planetary surface systems capabilities.
- Deep space operations and communications experience and facilities including NASA's Deep Space Network.
- An astronaut corps and associated human space flight training facilities.

The United States has also announced plans to develop a Crew Exploration Vehicle (CEV) to carry human crews to the Moon. The CEV may also be the basis for a spacecraft to eventually take humans to Mars. NASA is also studying possible development of a heavy lift launch vehicle that would carry future crew transport vehicles to destinations beyond low Earth orbit. As noted above, NASA is developing a nuclear fission reactor to provide propulsion and power for future space missions. Advanced optical communications capabilities to increase significantly the communications data rate between the Moon and Mars and Earth are also being developed.

Summary

The above discussion of the capabilities of selected countries and organizations is intended to illustrate that there are potential partners who could make a variety of contributions to future exploration initiatives. Other countries—for example Australia, Brazil and South Korea—may in the coming years also develop specific exploration interests and potential capabilities. Still other countries that currently do not have significant space programs may also wish to participate.

Future contributions from these prospective partners can come in many forms. Some might involve development of new space and ground systems. Others could involve using existing capabilities to provide redundancy in provision of launch and return sites, tracking and communications support, and terrestrial research and development capabilities.

Private Sector Participation

Though private sector organizations will develop, build and operate many of the capabilities that are used in exploration programs, this study assumes that governments will provide most of the funding to initiate and conduct the early space robotic and human exploration missions. The cost of such missions is too great and the potential for commercial exploitation is too vague for private investors to play lead roles in the first missions.

At the same time, the role played by the private sector in future exploration initiatives will be a crucial one. Private sector organizations can:

- **Utilize commercially developed technologies for space exploration purposes.** Technologies developed for commercial applications – in fields such as communications and computer systems – are rapidly evolving. Some of these technologies could potentially be utilized to enhance space systems and do so at lower cost than if they were custom-developed. For example, the private sector could develop the technology and provide the satellites and the ground facilities for relaying scientific data, voice and video signals from the Moon and Mars back to Earth. NASA hopes to stimulate the development and use of new technologies and in February 2004 announced plans to establish a *Centennial Challenges* program that will award annual prizes for “breakthrough” accomplishments that advance solar system exploration.
- **Provide space exploration operations support services.** Private sector organizations currently provide operational support for robotic and human space flight missions conducted by space agencies around the world. For future cooperative space exploration missions, these operations support activities could be provided by one or more multi-country private sector teams. For example, a private sector team could provide launch services to carry water and supplies to low Earth orbit in support of future human missions to the Moon and Mars. Compared to their government counterparts, private sector organizations are often more flexible, are better able to forge international relationships in a timely fashion and can be more cost efficient in providing the required support.
- **Invest in private sector space exploration projects.** As initiatives involving exploration beyond low Earth orbit progress, private sector opportunities are likely to arise. These opportunities could include exploitation of resources on the Moon, asteroids and Mars, in situ product development and production, and space tourism. The private sector is well suited to identifying and pursuing these opportunities. In the United States several private firms are currently developing low cost space launch systems. In addition the X Prize foundation is promoting interest in space tourism by offering a prize to the first team that privately builds and launches a spaceship able to carry the equivalent of three people to 100 kilometers, returns the spaceship and crew safely to Earth, and repeats the same mission with the same ship within two weeks.

Eventually, as potential commercial activities are identified, opportunities for exploration missions funded by the private sector may also arise. Such missions could ultimately play an important role in robotic and human exploration of our solar system.

Cooperation Approaches

Over the past forty years countries have chosen to cooperate on space projects not for altruistic reasons but to:

- Enrich the scientific and technological character of the initiative
- Help share the cost
- Gain access to foreign facilities and capabilities
- Increase robustness and redundancy
- Promote national scientific, technological and industrial capabilities
- Pursue foreign policy objectives

In deciding to proceed, the participating countries have weighed the advantages of cooperation against potential disadvantages such as:

- Increased risk
- Additional management complexity and coordination responsibilities
- Technology transfer and national procurement constraints
- Potential changes in priorities and funding among participating countries

While the approaches to international space cooperation have varied widely over the past 40 years, most of them fall into one of the following general categories:

- **National—with participants making non-critical path contributions.** This approach involves national space missions that include minor, non-mission critical participation by other countries. Such participation could include membership in scientific teams, provision of instrumentation and satellite tracking and data acquisition support. This is the approach the United States took for the Apollo program. It has also been utilized in a variety of robotic scientific missions undertaken by Europe (e.g. *Giotto*), Japan (e.g. *Nozomi*), and the United States (e.g. *Mars Exploration Rovers*).

- **Bilateral—one lead participant with other critical contributions.** This cooperation approach involves close collaboration among two or more participants, where the “junior” participant(s) makes significant contributions that are required for the overall success of the mission. Examples of this model include the *Vega*, *Phobos*, *Galileo* and *Cassini-Huygens* planetary missions and the Hubble Space Telescope program as well as the *Spacelab* and *Canadarm* projects.



Robotic planetary missions have often featured multi-national participation. This image of Saturn was taken in February 2004 as the international Cassini-Huygens mission approached the ringed planet. (Courtesy NASA/JPL)

- **Bilateral—roughly equal participation.** This approach involves contributions of roughly equal scope and complexity. The *Apollo-Soyuz*, *Tropical Rainfall Monitoring Mission* and *Topex-Poseidon* programs are examples of this model.

- **Multilateral—coordination:** This approach has been followed successfully by Canada, France, Russia and the United States for the COSPAS-SARSAT search and rescue program and by ESA, Japan, Russia and the United States in establishing the Inter-Agency Consultative Group (IACG) for the 1986 Halley’s Comet watch. A similar approach has been followed by a group of space agencies who in 1984 established the Committee on Earth Observing Satellites (CEOS) to help coordinate Earth observations missions and related activities, CEOS currently has 23 members (mostly space agencies) and 21 associated national and international organizations. Each of these groups seeks to coordinate national program initiatives in support of common international goals and objectives. The participating agencies seek to harmonize their national objectives, coordinate national missions to minimize duplication and fill-in gaps, and establish common standards and interfaces. Though cooperation can, and often does, occur among the participating agencies, the missions coordinated are still national ones, pursued for national reasons.
- **Multilateral—one lead participant with other critical and non-critical contributions.** This is the approach that Canada, Europe, Japan and the United States utilized when initiating the International Space Station program. Russia was later invited to join in the Space Station program. The United States—which contributed roughly two-thirds of the program costs—is the lead participant. Canada, Europe, Japan and Russia have made lesser contributions and share proportionally in the available research opportunities. Since the Columbia Shuttle accident in February 2003 the contributions of Russia in providing cargo and crew exchange have been essential for the continued operation of the Space Station. Canada’s contributions to the Station’s robotic capabilities have also been crucial. Though the research facilities developed by Europe and Japan are not essential to the functioning of the Space Station, these contributions help ensure the Station achieves its full research potential. In addition, both Europe and Japan are developing cargo re-supply systems that are likely to play critical roles in Space Station operations during the period after Space Shuttle flights are terminated.
- **Multilateral—weighted participation.** This is the approach that European Space Agency member countries take to determining national participation in ESA optional programs such as ENVISAT or Aurora. This is not a cooperation model per se, since ESA operates as a single agency. But this approach offers some features and experiences that may be useful in structuring future international exploration initiatives. For example, under the *juste retour* principle, ESA member states are assured of receiving approximately the same amount in industrial contracts as they contribute to optional ESA programs. In situations where *juste retour* is not achieved, special measures are adopted to ensure that countries with under return receive additional industrial contracts. This approach to cooperation increases the management complexity and the total cost of space projects. But the ESA optional program approach can be a powerful stimulator for cooperation and has been successfully used in a number of European programs such as the development of the Ariane launcher.

What is the best cooperation approach to pursuing future space exploration missions? This determination must be made by the governments and organizations that conduct the missions—taking into account their interests, goals and proposed contributions.

As a first step, the countries pursuing space exploration visions may wish to establish a mechanism to exchange information on long-term visions and program plans. Such exchanges could be used to harmonize national program activities by avoiding unnecessary duplication, filling gaps and establishing standard interfaces. These changes could result in the development of interoperable systems and increase the robustness of national exploration activities.

Since national exploration visions are likely to differ, the steps each country pursues, the funding provided and the schedules followed will also differ. Accordingly countries interested in cooperating on space exploration may prefer to do so on a step-by-step or project-by-project basis instead of committing themselves to long term, multiple mission engagements. In cases where more than one country is interested in and can contribute to pursuing a specific project, opportunities for cooperation may exist. In other cases, countries may prefer to pursue parallel initiatives that are coordinated and add redundancy and resiliency to the respective programs. Other steps may be taken by individual countries on a national basis with limited or no collaboration.

When projects involving more than one country are envisaged, the potential participants can utilize the cooperation approach they deem best suited to the specific project. For example, for robotic missions to the Moon, Mars and asteroids, the preferred cooperation approaches may be similar to those used in the past for national and bilateral robotic planetary missions. As planning proceeds for future human missions beyond low Earth orbit, additional approaches to cooperation may need to be considered. In this regard, and assuming that several countries express interest in cooperating, three of the above approaches offer features that merit particular consideration. They are the:

- *Multilateral-coordination* approach that appears well suited to minimize unnecessary duplication, fill programmatic gaps and harmonize long term goals of countries pursuing exploration missions,
- *Multilateral—one lead partner with other critical and non-critical contributions* approach that was followed by the International Space Station program partners, and the
- *Multilateral—weighted participation* approach used by the European Space Agency member states to conduct optional programs.

By pursuing the *Multilateral-coordination* approach space faring countries can broaden the scope and enhance the robustness of their programs and can identify opportunities for cooperation on specific next steps. As countries consider opportunities for government-to-government cooperation on future human exploration projects, the approaches utilized in the *Multilateral—one lead partner with other critical and non-critical contributions* and the *Multilateral—weighted participation* – can be considered. These approaches utilize space program management and organizational mechanisms that have functioned effectively for many years.

Ultimately, the approaches selected for coordination of and cooperation on future robotic and human exploration missions will be determined by those countries seeking to participate, will probably be hybrid approaches drawing features from several earlier models, and will likely evolve as experience is gained from each successive step.

Countries planning to cooperate on future exploration projects should also consider the “lessons learned” from past international space projects. Several of these lessons are discussed below.

Lessons Learned

During the past forty years, countries cooperating on space ventures have learned many useful “lessons” from their joint undertakings. Among those “lessons learned,” the following could prove helpful to those who seek to forge effective international partnerships on exploration missions:

- **Clear goals as well as a clear set of “rules of the road” must be identified and agreed to by all the participating countries.** Where this does not occur, the participants may encounter difficulties. Some goals may be based on national considerations and therefore not apply to all the partners. But each participant should be aware of the goals of the other participants even if these goals are not held in common.
- **When significant participation of other countries is envisaged, the prospective participants should be encouraged to take part in the definition of program requirements.** Such participation will build interest in and facilitate the definition of potential international contributions. If one country anticipates providing most of the funding, that country will of course lead the process and retain ultimate responsibility for setting the requirements.
- **Each individual participant should recognize the “benefits” and the “costs” of the proposed venture and understand that the benefits and costs will vary among the participants.** That differing benefits are sought means that there will be differing definitions of project success to be considered as the project progresses. The benefits can be technological, financial and political as well as scientific, educational, and cultural. The costs can be associated with duplicated effort, additional overhead and added time for coordination. While each participant needs to consider the respective benefits and costs, the calculation of relative benefits and costs will certainly vary from participant to participant.
- **The participants must also recognize that long-term projects can suffer from changing political and funding conditions and differing processes.** The budget process in some countries, like the United States for example, makes it impossible to guarantee future appropriation of government funds. This situation is compounded when a number of countries and space agencies are involved. The changing political and funding support for the International Space Station program illustrates this point. Pursuing a series of shorter projects in an incremental fashion as part of a long-term plan could help mitigate—but will not completely eliminate—this problem.

- **In considering which form of legal arrangement to seek, the participants should balance their desire for binding commitments against the need to be pragmatic and to accommodate changes.** Treaty commitments can supersede national legislation and regulatory requirements – for example, export controls – that may inhibit the success of cooperative projects. However, treaties are very difficult to conclude and ratify and may not *in practice* significantly increase the level of commitment or help participants overcome regulatory constraints.
- **Successful international partnerships often involve international interdependencies that require a high degree of:**
 - **Flexibility** to accommodate changing circumstances. The participating partners need to strike a balance between honoring long term commitments and maintaining flexibility to adjust to changing circumstances. In the case of changing circumstances, they need to aim at finding solutions agreed upon in common.
 - **Openness** among the partners about developments that could impact the cooperation.
 - **Tolerance** of cultural differences and varying management approaches.
 - **Respect** for agreed processes and rules.

As the potential participants begin planning a joint initiative, these and other lessons learned will hopefully provide useful background information that will help them pursue future space exploration missions in a mutually successful fashion.

Next Steps

This study presents a vision and rationale for future space exploration beyond low Earth orbit and describes some of the factors to be considered in pursuing future exploration missions. The Study does not suggest which countries should be involved and under what conditions. These matters must be decided by the nations that collaborate on space exploration projects.

At the same time, in concluding the Study it seems appropriate to identify steps that countries interested in space exploration could take to facilitate prospects for future collaboration. These steps could include the following:

- **Seek increased coordination of and cooperation on future robotic exploration missions.** In preparing to pursue human exploration initiatives, space agencies should consider expanding cooperation on robotic exploration missions now being planned. For example, CASC, ESA, FKA, ISRO, JAXA and NASA are studying robotic missions to the Moon, Mars, Jupiter, Mercury, Venus and Pluto during the 2008-2020 time period. While some of these agencies have expressed interest in international collaboration, others have—in recent years—placed increased attention on national missions that cannot be jeopardized if the commitments of the international partners are not fulfilled. By working closely together on robotic missions, countries can spread the cost and increase the scientific return from their

efforts. Collaboration on robotic missions can also help define common scientific interests to be pursued during subsequent human exploration activities.

- **Establish a mechanism for information exchange and coordination.** As space agencies pursue their robotic and human exploration program interests, perhaps the time has come to establish a new group to exchange information, coordinate plans, and when possible harmonize long term visions. Two existing groups already exchange information on robotic missions: The International Mars Exploration Working Group (IMEWG) was established in 1993 and the International Lunar Exploration Working Group (ILEWG) established in 1994. While IMEWG and ILEWG have been highly successful, it may be desirable to create a new group that addresses overall robotic and human space exploration interests. If established this group could take an approach similar to that of the Committee on Earth Observing Satellites (CEOS) which includes agencies actively planning or conducting missions, seeks to coordinate these activities to minimize duplication and avoid gaps, and advocates standard interfaces. A CEOS-type group for space exploration could also facilitate the pursuit of new cooperation projects and allow the participants to discuss and, when possible, harmonize their respective goals.
- **Expand the use of international launch and logistics capabilities to provide increased redundancy and resiliency.** The countries participating in the International Space Station program are already making use of their respective capabilities to ensure continued operation of the Station during the period that the Space Shuttle is not being launched. A recent proposal by NASA—contained in its Fiscal Year 2005 budget request—anticipates increased use of partner capabilities for both crew exchange and for cargo support during the coming years. Assuming these steps are taken, they will demonstrate the potential to utilize launch and logistics systems from several countries to support future missions beyond low Earth orbit. A further step, being discussed by several Space Station partners, involves establishing standard interfaces for designated flight elements so they can be launched on more than one launch vehicle. If this were done, it might be possible to launch cargo vehicles—such as Europe’s Automated Transfer Vehicle (ATV) and Japan’s H-2A Transfer Vehicle (HTV)—on launch vehicles provided by other partners. This could increase the flexibility and the robustness of the Space Station program and could set a useful precedent for the future.
- **Agree in advance on ground rules for private sector participation** and on a legal framework for exploration activities funded and executed by the private sector. These steps can help facilitate private sector initiatives associated with space exploration and at the same time minimize difficulties that could otherwise occur. In addition, if extensive international cooperation at the industry-to-industry level is envisioned, the participating governments will need to agree on and implement mutually acceptable arrangements to permit and expedite the exchange of equipment and technical data that is subject to national export controls.
- **Approach cooperation in a step-by-step fashion focusing on individual projects.** This avoids the difficulties of trying to reach agreement on a long term (ten to twenty year) program that cannot be fully defined and the cost of which would be difficult to estimate. By approaching cooperation on a “one step at a time” basis, the number of participants and the

contributions they make can vary from step to step. The potential participants can select the cooperation approach that best suits the proposed project. The cooperation approaches described above as well as cooperation approaches utilized in other scientific and technological programs can be considered as “tools” that are available for use. In some cases the participants may elect to select features from several past approaches and create new, hybrid cooperation tools. After each step has been taken the participants can apply the lessons learned to the next step to be taken.

While coordinating and cooperating with international partners can increase the complexity and the overall cost of national exploration activities, international coordination and cooperation—with the funding burden spread among several partners—can make space exploration activities more affordable, sustainable and attractive to each of the participants.

International collaboration on space exploration also provides opportunities for countries – some of which might otherwise be competitors – to work together on challenging enterprises that increase human knowledge and promote peaceful utilization of the solar system.

Resources

The following materials were used by the study team in constructing this report.

Magazines

- “Man Will Conquer Space Soon”, Collier’s Magazine, March 22, 1952, p.22
- “Man on the Moon”, Collier’s Magazine, October 18, 1952, p.51
- “Man on the Moon: The Exploration”, Collier’s Magazine, October 25, 1952, p.38
- “Can We Get to Mars”, Collier’s Magazine, April 30, 1954, p.22

Books

- Lewis, John. *Rain of Fire and Ice*, Addison-Wesley, New York, 1996.
- Lewis, John. *Mining the Sky*, Perseus Publishing, New York, 1997.
- Newell, Homer E., *Beyond the Atmosphere: Early Years of Space Science*, NASA SP-4211, 1980
- Pellinen, Risto and Raudsepp, Paul eds., *Toward Mars*, Raud Publishing, Helsinki, 2000.
- Sykes, M.V., ed., *The Future of Solar System Exploration, 2003-2013* (Astron. Soc. Pacific, San Francisco, 2002).

Science and Engineering Publications

- Condon, G. L. and Pearson, D. J., “The Role of Humans in Libration-Point Missions with Specific Application to an Earth-Moon Libration-Point Gateway Station,” *Advances in the Astronautical Sciences: Astrodynamics 2001*, Vol. 109, pp. 95-110.
- Cooke, D. R., et al., “Innovations in Mission Architectures for Exploration Beyond Low Earth Orbit,” *IAC Paper 02-Q.6.04*, October 2002.
- *COSPAR Planetary Protection Policy* accepted by the Council and Bureau, as moved for adoption by SCF&PPP. Prepared by the COSPAR/IAU Workshop on Planetary Protection, April 2002 with updates October 2002.
- Crawford, I. A. “The Scientific Case for a Human Spaceflight Infrastructure” *Earth, Moon and Planets*, Vol. 87, 221-231, 2001.
- Crawford, I. A. “Back to the Moon?” *Astronomy and Geophysics* Vol. 44, 2.15-2.17, 2003.
- Drake, B. G., et al., “Technologies for Human Space Exploration: Earth’s Neighborhood and Beyond,” *AIAA Paper 2001-4634*, August 2001.
- Dunham, D. W. and Roberts, C. E., “Stationkeeping Techniques for Libration-Point Satellites,” *Journal of the Astronautical Sciences*, Vol. 49, No. 1, January-March 2001, pp. 127-144.
- Farquhar, R. W., “Future Missions for Libration-Point Satellites,” *Astronautics & Aeronautics*, May 1969, pp. 52-56.
- Farquhar, R. W., “The Control and Use of Libration-Point Satellites,” *NASA TR R-346*, September 1970.
- Farquhar, R. W., “A Halo-Orbit Lunar Station,” *Astronautics & Aeronautics*, Vol. 10, No. 6, June 1972, pp. 59-63.

- Farquhar, R. W., and Dunham, D. W., "Use of Libration-Point Orbits for Space Observatories," *Observatories in Earth Orbit and Beyond*, Ed. by Y. Kondo, Kluwer Academic Publishers, 1990, pp. 391-395.
- Farquhar, R. W., Dunham, D. W., Guo, Y., and McAdams, J. V., "Utilization of Libration Points for Human Exploration in the Sun-Earth-Moon System and Beyond", IAC Paper 03-IAA.13.2.03, October 2003.
- Farquhar, R. W., "The Flight of ISEE-3/ICE: Origins, Mission History, and a Legacy," *Journal of the Astronautical Sciences*, Vol. 49, No. 1, January-March 2001, pp. 23-73.
- Foing, B. H. and S. Dunkin Eds., Special Issue on Lunar Exploration, *Planetary and Space Science*, Vol. 50, issue 14-15, 2002.
- Foing B. H. and D. Heather Eds., Lunar Exploration 2000, *Adv. Space Res.* Vol. 30, No. 8, 2002.
- Foing, B. H., R. Manka and D. Lemke Eds., Missions to the Moon and Exploring the Cold Universe, *Adv. Space Res.* Vol. 18 No. 11, 1996.
- Foing, B. H. Ed., Astronomy and Space Science from the Moon, *Adv. Space Res.* Vol. 14 No. 6, 1994.
- Folta, D. C., et al., "Servicing and Deployment of National Resources in Sun-Earth Libration-Point Orbits," *IAC Paper 02-Q.6.08*, October 2002.
- Haignere, J-P. (France), Gorshkov, L. (Russia), Kawaguchi, J. (Japan), Young, J. (USA), Farquhar, R. (USA), Huntress, W. (USA), "Humans Beyond Earth Orbit Plenary", World Space Congress II October 2002, *Acta Astronautica* (in publication).
- Huntress, W. T., "Human Space Exploration Is About More Than Just Science," *Science*, Vol. 301, August 8, 2003, p.771.
- Ip, W., B. H. Foing, and Ph. Masson Eds., The Moon and Mars, *Adv. Space Res.* Vol. 23, No. 11, 2000.
- Joosten, B. K., "Human Space Exploration in Earth's Neighborhood--Strategy and Architectural Approach," *AIAA Paper 2001-4561*, August 2001.
- Kawaguchi, J. and Yoshimura, M., "Deep Space Quay at L2 and Low Thrust Departure/Return Flight Strategy," *16th International Symposium on Space Flight Dynamics*, Pasadena, California, December 2001.
- Lester, D. F., York H. W. and Mather, J. C. "Does the Lunar Surface Still Offer Value as a Site for Astronomical Observatories?" *Space Policy*, May 2004.
- [Opinion] "Do We Still Need Astronauts?," *Nature*, Vol. 419, October 17, 2002, p. 653.
- Reichhardt, T., "A Million-Mile Service," *Nature*, Vol. 419, October 17, 2002, p. 666.
- Spudis, P. D. "The Case for Renewed Human Exploration of the Moon" *Earth, Moon and Planets*, Vol. 87, 159-171, 2001.

International Academy of Astronautics publications

- Preparing for a 21st Century Programme of Integrated Lunar and Martian Exploration and Development, IAA 5th Cosmic Study, H. H. Koelle and D. G. Stephensen, 1998.

U.S. National Academy of Science Space Studies Board Publications

- *Scientific Prerequisites for the Human Exploration of Space*, Washington, D.C.: National Academy Press, 1993.

- *Scientific Opportunities in the Human Exploration of Space*, Washington, D.C.: National Academy Press, 1994.
- *An Integrated Strategy for the Planetary Sciences: 1995-2010*, Washington, D.C.: National Academy Press, 1994.
- *Assessment of Mars Science and Mission Priorities*, Washington, D.C.: National Academy Press, November 2001.
- *Astronomy and Astrophysics in the New Millennium*, Washington, D.C.: National Academy Press, 2001.
- *New Frontiers in the Solar System: An Integrated Exploration Strategy*, Washington, D.C.: National Academy Press, 2002.
- *NASA Exploration Team FY02 Annual Report*, NASA, 2002.
- *Workshop on the Future of Human Space Flight*, Washington, D.C.: National Academy Press, in press 2004.

U.S. National Aeronautics and Space Administration Science Exploration Plans

- *A Road Map for the Exploration of Neighboring Planetary Systems*, Jet Propulsion Laboratory, August 1996.
- *Origins: A Roadmap for the Office of Space Science Origins Theme*, Office of Space Science, July 1997 and April 2000.
- *The Space Science Enterprise Strategic Plan*, Office of Space Science, November 1997 and November 2000.
- *Science Planning for Exploring Mars*, Jet Propulsion Laboratory, July 2001.
- *Solar System Exploration*, Office of Space Science, 2003.

United States Publications:

- *Pioneering the Space Frontier* (“Paine Report”), 1986.
- *Leadership and America’s Future in Space* (“Ride Report”), 1987.
- *Space Science in the 21st Century*, 1988.
- *A New Era in Space* (First “Stever Report”), 1988.
- *The Human Exploration Initiative* (“90-Day Study” or “Cohen Report”), 1989.
- *Review of NASA’s 90-Day Study* (“Second Stever Report”), 1990.
- *Report of the Advisory Committee on the Future of the U.S. Space Program* (“Augustine Report”), December 1990.
- *America at the Threshold* (“Stafford Report”), 1991.
- *National Aeronautics and Space Administration 2003 Strategic Plan*, 2003.
- “A Renewed Spirit of Discovery,” The President’s Vision for U.S. Space Exploration, 2004.
- Fiscal Year 2005 Budget Request for NASA, 2004.

European Publications:

- *Mission to the Moon*. ESA SP-1150, 1994.
- Bonnet, Roger M. and Manno, Vittorio, *International Cooperation in Space: The Example of the European Space Agency*, Harvard University Press, Cambridge, 1994.
- *Investing in Space: The Challenge for Europe*, Long-Term Space Policy Committee, Second report, ESA SP-2000, 1999.

- *Exobiology in the Solar System and the Search for Life on Mars*, ESA SP-1231, 1999.
- Science Planning Committee Long Term Science Vision, 2003
- Aurora Programme Proposal, 2001 and Aurora Programme Executive Summary, 2004.
- *Moon: the 8th Continent*, Final Report of the Human Spaceflight Vision Group, 2003
- *Space: A New Frontier for an Expanding Union*, European Union White Paper and Space Policy Action Plan, 2003.

Japanese Publications:

- *Toward Creation of Space Age in the New Century*, Special Committee on Long Term Vision, Space Activities Commission, 1994.
- Space Development Plan, Space Activities Commission, 2000.

Russian Publications:

- *Preliminary Project for Human Exploration of Mars*, 2001. Results of an International Science and Technology Center study project (ISTC Project 1172) conducted by Russian, U.S. and European experts from 1999 to 2001.

Presentations and Professional Society Publications

- Huntress, Wesley T. Jr. Presentation Package to the Honorable Dan Goldin, "Grand Challenges for Space Exploration," May 1998.
- Huntress, Wesley T. Jr. "Grand Challenges for Space Exploration," *Space Times* Vol. 38, No. 3, May-June 1999.
- Huntress, Wesley T. Jr. "An Exciting Future for Human Spaceflight," *Space Times* Vol. 42, No. 6, Nov-Dec 2003.

Visits and Discussions

- Visits by Wesley T. Huntress, Jr., for discussions with planetary science faculty and students at Brown University and Cornell University on scientific exploration of the Solar System by robots and humans.
- Discussion led by Jonathan Lunine with graduate students at the University of Arizona on scientific exploration of the Solar System by robots and humans.
- Visit by Wesley T. Huntress, Jr., to the Goddard Space Flight Center for discussions with science staff on the future of space astronomy.
- Visits by James V. Zimmerman to Bonn and Bremen, Germany, Noordwijk, the Netherlands, Paris and Toulouse, France and Rome, Italy for discussions with current and former European space officials.
- Discussions by Roger Bourke, Geraldine Naja, Risto Pellinen and James V. Zimmerman with current and former space officials in Brazil, Canada, India, Japan, and Russia.
- Discussion by James V. Zimmerman with Roger M. Bonnet, former Director of Scientific Programmes, European Space Agency and current President of the Committee on Space Research (COSPAR) on space cooperation models and future approaches.

- Discussions by James V. Zimmerman with Joan Johnson-Freese, Professor, U.S. Naval War College on the space programs of China and Japan as well as on space cooperation models and lessons learned.

Testimony

- Testimony by Wesley T. Huntress, Jr., before the Subcommittee on Space and Aeronautics, Committee on Science, U.S. House of Representatives, on “Grand Challenges for America’s Space Program” April 3, 2001.
- Testimony by Wesley T. Huntress, Jr., before the U. S. Presidential Commission on the Future of the United States Aerospace Industry (Walker Commission), on a science-based vision of the future of space exploration, May 14, 2002.
- Testimony by Wesley T. Huntress, Jr., before the Committee on Science, U.S. House of Representatives on “The Future of Human Space Flight” October 16, 2003.
- Testimony by Wesley T. Huntress, Jr., before the Committee on Commerce, Science and Transportation, U.S. Senate, on “The Future of NASA” October 29, 2003.

Conferences and Workshops

- International Lunar Workshop, 1994 May 31-June 3, Beatenberg, Switzerland, ESA-SP-1170. (Ed. H. Balsiger, et al.) 1994.
- Space Exploration and Resources Exploitation Workshop, 1998 Oct 20-22, Cagliari, Sardinia, Italy, ESA-WPP-151, 1998.
- 4th International Conference on Exploration and Utilisation of the Moon, ESTEC, ESA SP-462 (B.H. Foing & M. Perry, editors) 2000.
- New Views of the Moon, Europe: Future Lunar Exploration, Science Objectives, and Integration of Datasets, Workshop at DLR, Berlin, Jan 14-16, 2002.
- ESLAB36 Symposium on “Earth-like Planets and Moons”, ESA-SP514 (B.H.Foing & B. Battrick, editors) 2002.
- ESA/IAA Workshop on “The Next Steps in Exploring Deep Space,” B. H. Foing and W. T. Huntress, Jr. conveners, 22-23 September 2003, ESTEC, Noordwijk, Netherlands.